



# Terlingua 2022

**Electric 4X4  
Vehicles**

**Owner's Manual  
All Electric Models**

Warranty information appears at the end of this manual. No other warranties, expressed or implied, are contained herein. Your authorized representative checked the vehicle before it was delivered to you and will provide you a copy of the completed vehicle warranty registration form.

HuntVe is not liable for errors in this manual or for incidental or consequential damages that result from the use of the material in this manual.

This manual contains proprietary information that is protected by copyright. All rights are reserved. No part of this manual may be photocopied, reproduced, or translated to another language without the written consent of Martex Global Enterprise L.L.C.

The information contained in this document is subject to change without notice.

Martex Global Enterprise L.L.C. reserves the right to make design changes to vehicles without obligation to make these changes on units previously sold.

These vehicles do not conform to Federal Motor Vehicle Safety Standards for automobiles or to FMVSS 500 for low-speed vehicles, and are not equipped for operation on public streets, roads, or highways.

*HuntVe*, registered trademarks of Martex Global Enterprises L.L.C.  
This manual effective July 2021.

## FOREWORD

Thank you for choosing HuntVe™, the industry leader in vehicle efficiency and long-lasting value. You have chosen the finest vehicle on the market. Please protect your investment and ensure that your HuntVe vehicle(s) provides years of reliable, superior performance by reading and following the maintenance instructions in this manual.

Your comfort and safety are important to us, so we urge you to read and follow the step-by-step operating instructions and safety procedures in this manual. These instructions must be followed in order to avoid the risk of severe personal injury. If you rent or loan your vehicle to others, we recommend that you ask them to read this manual before they operate the vehicle.

HuntVe products are backed by a customer support system designed to offer you fast, courteous service. In the event that your HuntVe vehicle needs repairs or service, we recommend that your local authorized HuntVe representative perform them. For the name and address of the HuntVe representative nearest you, logon to our web site at [www.HuntVe.com](http://www.HuntVe.com) or call 1.888.554.5953. Your local authorized HuntVe representative can also provide technical advice, parts, and service manuals.

We hope you will consider this owner's manual a permanent part of your HuntVe vehicle. If you sell the vehicle, please include the manual so that the next owner will have the important operating, safety, and maintenance information it contains.

## TABLE OF CONTENTS

Safety Information/ Details .....	4
Practice Safety .....	4
Proposition 65 – State of California .....	4
General Warnings .....	6
General Information .....	8
Model Identification .....	9
Controls and Indicators .....	9
Pre-Operation and Daily Safety Checklist .....	11
Performance Inspection .....	12
Driving Instructions .....	13
Loading and Unloading – Box Bed Vehicles .....	15
Towing the Vehicle .....	16
Transporting on a Trailer .....	17
Storage .....	17
Maintenance .....	19
Periodic Service Schedule .....	19
Periodic Lubrication Schedule .....	20
Vehicle Controller .....	22
Batteries .....	23
Battery Charger .....	25
Cleaning the Vehicle.....	28
Accessories .....	29
Subsequent Owner Registration.....	29
Specifications – HuntVe .....	30
Warranty .....	31

## **SAFETY INFORMATION**

The following pages contain safety feature identification information. For detailed information on specific features, read the appropriate section in this manual.

### **PRACTICE SAFETY**

Safety signs like you see above may at first seem shocking, but their impact is mild compared with the reality of severe personal injury.

Your safety and satisfaction are of the utmost importance to us. That is why before operating the vehicle, we urge you to review the information in this manual. Understand and become familiar with the DANGER, WARNING, and CAUTION statements and procedures it contains, along with the safety decals that are affixed to your vehicle. Take time to understand the language of safety. It is a language that can save your life.

## **PROPOSITION 65 – STATE OF CALIFORNIA**

### **WARNING**

- **This product contains or emits chemicals or substances that have been determined by the state of California to cause cancer and birth defects or other reproductive harm.**

## **SAFETY DETAILS**

### **WARNING**

- **This owner's manual should be read completely before attempting to drive or service the vehicle. Failure to follow the instructions in this manual could result in property damage, severe personal injury, or death.**

It is important to note that some vital statements throughout this manual and on the decals affixed to the vehicle are preceded by the words DANGER, WARNING, or CAUTION. For your protection, we recommend that you take special notice of these safety precautions. Safety precautions are essential and must be followed.

Throughout this manual the word "vehicle" is used in reference to any vehicles covered in this manual, or may be used when referring to all vehicles.

If any of the operation or safety decals on the vehicle become damaged, have been removed or cannot be easily read, they should be replaced immediately to avoid possible property damage, personal injury, or death. Contact your dealer.

## **DANGER**

- A **DANGER** indicates an immediate hazard that will result in severe personal injury or death.

## **WARNING**

- A **WARNING** indicates an immediate hazard that could result in severe personal injury or death.

## **CAUTION**

- A **CAUTION** with the safety alert symbol indicates a hazard or unsafe practice that could result in minor personal injury.

## **CAUTION**

- A **CAUTION** without the safety alert symbol indicates a potentially hazardous situation that could result in property damage.

## **GENERAL WARNINGS**

The following safety statements must be heeded whenever the vehicle is being operated, repaired, or serviced. Other specific safety statements appear throughout this manual and on the vehicle.

### **DANGER**

**Battery – Explosive gases! Do not smoke. Keep sparks and flames away from the vehicle and service area. Ventilate when charging or operating vehicle in an enclosed area. Wear a full face shield and rubber gloves when working on or near batteries.**

Gasoline – Flammable! Explosive! Do not smoke. Keep sparks and flames away from the vehicle and service area. Service only in a well ventilated area. *SEE RANGE EXTENDING GENERATOR OWNER'S MANUAL FOR VEHICLES EQUIPPED WITH HYBRID FEATURE. THIS IS A SEPARATE DOCUMENT.*

**The vehicle will not provide protection from lightning, flying objects, or other storm-related hazards. If caught in a storm while driving a HuntVe vehicle, exit the vehicle and seek shelter in accordance with applicable safety guidelines for your location.**

## **WARNING**

**Follow the procedures exactly as stated in this manual, and heed all DANGER, WARNING, and CAUTION statements in this manual as well as those on the vehicle and battery charger.**

**Do not leave children unattended on vehicle.**

**Prior to leaving the vehicle unattended or servicing the vehicle, set the park brake, place the Forward/Reverse switch in the NEUTRAL position, turn the key switch to the OFF position, and remove the key.**

**Chock the wheels when servicing the vehicle.**

**Improper use of the vehicle or failure to properly maintain it could result in decreased vehicle performance, severe personal injury, or death.**

**Any modification or change to the vehicle that affects the stability or handling of the vehicle, or increases maximum vehicle speed beyond factory specifications, could result in severe personal injury or death.**

**Check the vehicle for proper location of all vehicle safety and operation decals and make sure they are in place and are easy to read.**

**Only trained technicians should service or repair the vehicle or battery charger.**

**Anyone doing even simple repairs or service should have knowledge and experience in electrical and mechanical repair.**

**The appropriate instructions must be used when performing maintenance, service, or accessory installation.**

**No more than the design passenger capacity (2 or 4 persons) should be in the vehicle at one time. Do not allow a passenger to ride in a cargo area.**

**Stop the vehicle completely before shifting the Forward/ Reverse switch.**

**To help prevent overturning the vehicle, drive slowly straight up and down slopes. Avoid driving side hills or slopes exceeding 20% incline.**

**To help avoid the possibility of losing control of or overturning the vehicle, reduce speed for adverse driving conditions such as wet grass or rough terrain.**

**Do not drive while under the influence of alcohol, drugs, or medication.**

## GENERAL INFORMATION

### HuntVe electric vehicles:

Place Tow/Run switch (see location on page 11) in the TOW position before disconnecting or connecting the batteries. Failure to heed this warning could result in a battery explosion or severe personal injury. *Furthermore, damage may result to the entire electronic system causing failure of the speed controllers.*

During service repair, to avoid unintentionally starting the vehicle, disconnect the batteries as shown. To disconnect the batteries 1) Ensure the Tow/Run switch is in the TOW (off) position 2) Disconnect the batteries, negative (-) cable first 3) After disconnecting the batteries, wait 90 seconds for the controller capacitors to discharge.

Wear safety glasses or approved eye protection when servicing the vehicle or battery charger. Wear a full face shield and rubber gloves when working on or near batteries.

Do not wear loose clothing or jewelry such as rings, watches, chains, etc., when servicing the vehicle or battery charger.

Use insulated tools when working near batteries or electrical connections.

Use extreme caution to avoid shorting of components or wiring.

Never submerge vehicle in water.

Check water level in batteries (lead acid) weekly.

Charge vehicle in a 50 degree or above environment for maximum charge efficiency.

To protect motor(s), DO NOT drive vehicle in rough terrain or high grade climbing when in a low state of charge.

To maximize motor performance, always use momentum of vehicle in hill climbing and muddy environments.

Never allow vehicle batteries to completely discharge. In the event batteries discharge to the point the vehicle will not run, contact a HuntVe service center if the charger will not turn on and recharge batteries. Discharging batteries to a low state of charge will damage batteries.



## MODEL IDENTIFICATION

HuntVe™/ Terlingua™/ Switchback™/Game Changer™ Model - The serial number of the vehicle is printed on a decal mounted under the dash, below the switch panel. (Example: 1HLD42B7BF861001)

**NOTE:** Have the vehicle serial number available when ordering parts or making inquiries.

## CONTROLS AND INDICATORS

- **If loaning the vehicle, make sure the driver is familiar with all controls and operating procedures before allowing the vehicle to be driven.**
- **Any modification or change to the vehicle that affects the stability or handling of the vehicle, or increases maximum vehicle speed beyond factory specifications, could result in severe personal injury or death.**
- **Do not shift the Forward/Reverse switch while the vehicle is moving. To avoid injury to an unsuspecting passenger or damage to the vehicle, always bring the vehicle to a full stop before shifting the Forward/Reverse handle or switch.**
- **Release the accelerator pedal and then press the brake pedal firmly until the vehicle stops. To avoid unintentionally starting or rolling the vehicle, set the park brake, place the Forward/ Reverse handle or switch in the NEUTRAL position, turn the key switch to the OFF position, and remove the key when leaving the vehicle.**
- **Never tow a vehicle with the TOW switch in the on position. Motor and controller damage will result.**

## KEY SWITCH

The key switch is mounted on the dash to the right of the steering column.. It has two positions, OFF to the left and ON to the right.

**NOTE:** The key can be removed only when the key switch is in the OFF position.

## HuntVe Vehicles

The Forward/Reverse rocker switch is located on the dash assembly upper left position. See The FORWARD and REVERSE positions are clearly marked. Push up for the FORWARD side of the switch to operate the vehicle in the forward direction, or push down the REVERSE side of the switch to operate the vehicle in reverse. When the rocker switch is positioned in NEUTRAL, with neither side down, the vehicle will not operate if the accelerator pedal is pressed.

## ACCELERATOR PEDAL

The accelerator pedal is the pedal on the right, it is adjustable for height and width. The operation of the accelerator pedal differs from that of an automobile. When the key switch is in the ON position, and the Forward/Reverse switch is in either the FORWARD or REVERSE position, pressing the accelerator pedal will start the vehicle moving in the direction selected (forward or reverse). As the accelerator pedal is pressed, speed will increase until full speed is reached. When the accelerator is released, power will be cut off and the motor will stop running.

## BRAKE PEDAL

The brake pedal is the large pedal on the left.

## PARK BRAKE HANDLE

The park brake pedal is located below the dash on the left side with the brake logo molded into it. To set the park brake, press the E brake pedal firmly and to release Push E brake pedal a second time. **See the following WARNING.**

### WARNING

- **The park brake may not hold on an incline more than 15%. You will need to chock the tires to prevent the vehicle from rolling.**

## TOW/RUN SWITCH

### WARNING

- **Place Tow/Run switch under the hood in the TOW position before disconnecting or connecting the batteries. Failure to heed this warning could result in a battery explosion or severe personal injury.**
- **When the Tow/Run switch is in the TOW position, all motor braking functions, including zero speed detect, are disabled.**

HuntVe vehicles are equipped with a Tow/Run switch (see page 11 for location). The switch must be in the RUN or on position in order to operate the vehicle. When the switch is in the TOW or off position, power to the vehicle electrical components is turned off and the vehicle will not operate. **See following NOTE.**

***NOTE: After placing the Tow/Run switch in the TOW position, allow 10 seconds to elapse before switching back to the RUN position. Quickly turning the tow switch on and off may confuse or damage the controllers.***

The Tow/Run switch should be placed in the TOW position under the following conditions:

- **Before Towing the Vehicle:** Place the Tow/Run switch in the TOW position to disable all motor braking functions, thus preventing possible damage that could occur to the vehicle or electrical components if the vehicle is towed while the zero speed detect motor braking function is operating.

- **Before Disconnecting or Connecting Battery Cables:** Place the Tow/Run switch in the TOW position to turn off power to the vehicle electrical system, thus preventing severe arcing and possible battery explosion as the battery cables are disconnected.
- **For Long-Term Storage:** Place the Tow/Run switch in the TOW position to turn off power to the vehicle electrical system, thus preventing vehicle electrical components from discharging the batteries.

## PRE-OPERATION AND DAILY SAFETY CHECKLIST

Each HuntVe™ vehicle has been thoroughly inspected and adjusted at the factory; however, upon receiving your new vehicle(s), you should become familiar with its controls, indicators, and operation. Carefully inspect each vehicle to ensure that it is in proper working condition before accepting delivery.

Use the following checklist as a guide to inspect the vehicle. This checklist should be used daily to ensure that the vehicle is in proper working condition and in conjunction with the Periodic Service Schedule on page 24. Any problems should be corrected by a HuntVe dealer or a trained technician.

- **General:** All the parts should be in place and properly installed. Be sure that all nuts, bolts, and screws are tight.
- **Tires:** Check for proper tire pressure. Visually inspect tires for wear, damage, and proper inflation on a daily basis. **See Specifications – on page 31.**
- **Batteries:** Check electrolyte to ensure that it is at the proper level (**Figure 14, Page 23**). Check battery posts. Wires should be tight and free of corrosion. On electric vehicles, charge batteries fully before first use of vehicle.
- **Charger cord, plug, and receptacle:** Visually inspect for cracks, loose connections, and frayed wiring. **See Plug and Receptacle on page 28.**

### TOW SWITCH LOCATION



ON OFF

## PERFORMANCE INSPECTION

After you have familiarized yourself with the vehicle controls and have read and understood the driving instructions, take the vehicle for a test drive.

Use the following checklist as a guide to inspect the vehicle and check daily for proper operation. Any problems should be corrected by a HuntVe dealer or a trained technician.

### All Vehicles

- **Forward/Reverse control:** Check for proper operation. **See Controls and Indicators on page 11.**
- **Brakes:** Be sure the brakes function properly. When brake pedal is fully pressed under moderate pressure, it should not go more than halfway to the floor, and vehicle should come to a smooth, straight stop. If the pedal goes more than halfway to the floor, or if the vehicle swerves or fails to stop, have the brake system checked and adjusted as required. Brake adjustment must be maintained so that the brake pedal cannot be pressed to the floor under any circumstance.
- **Park brake:** When latched, the park brake should lock the wheels and hold the vehicle stationary (on an incline of 20% or less). It should release when either the accelerator or brake pedal is pressed.
- **Steering:** The vehicle should be easy to steer and should not have any play in the steering wheel.
- **Accelerator:** With the key switch in the ON position and the Forward/Reverse switch in the FORWARD position, as the accelerator pedal is pressed, the motor should start and the vehicle should come up smoothly to full speed. When the pedal is released it should return to the original position and the motor should rotate freely. All HuntVe vehicles operate at reduced speed in reverse.
- When the pedal is released it should return to the original position and the motor should rotate freely or go into motor braking mode. **See Pedal Up Motor Braking below.**
- **General:** Listen for any unusual noises such as squeaks or rattles. Check the vehicle's ride and performance. Have a HuntVe dealer or a trained technician investigate anything unusual.

### WARNING

- **Do not operate vehicle on slopes exceeding 30% grades.**
- **Pedal Up Motor Braking (adjustable on HuntVe vehicles):** Accelerate the vehicle to full speed and then release the accelerator pedal. Motor braking should quickly and smoothly slow the vehicle. This feature is adjustable for HuntVe vehicles only. Contact your local HuntVe dealer/distributor to inquire about this adjustable feature.
- **Pedal Down Driving:** Accelerate down an incline with the accelerator pedal pressed. On very steep grades, the vehicle may slightly exceed its maximum designed speed, requiring use of the brake pedal.

# DRIVING INSTRUCTIONS

## WARNING

- Only licensed drivers should be allowed to drive the vehicle.
- If loaning the vehicle, make sure the driver is familiar with all controls and operating procedures before allowing the vehicle to be driven.
- No more than two people should be on the vehicle at one time, except for the 4-passenger vehicle, which can carry four people.
- The vehicle is not specially equipped for handicapped persons: Be sure all persons can properly operate the vehicle prior to allowing them to drive the vehicle. Be sure all passengers are capable of securing themselves in a vehicle before allowing them to ride in one.

## WARNING

- For night use, the vehicle must be equipped with headlights, taillights and reflectors.
- Stop the vehicle before shifting the Forward/Reverse handle. Failure to do so may result in injury to an unsuspecting passenger and (or) damage to the vehicle.
- To help avoid being struck, do not stand in front of or behind the vehicle.
- Operate the vehicle from the driver seat only.
- To help prevent falls from the vehicle, remain seated in a moving vehicle and hold on to hand holds or handrails at all times. Driver should keep both hands on the steering wheel when the vehicle is in motion.
- To help prevent the possibility of serious injury, keep your entire body inside the vehicle.
- Do not leave children unattended on vehicle.
- To help prevent overturning the vehicle, drive slowly straight up and down slopes. Avoid driving the vehicle on slopes exceeding 40% incline.
- To help avoid possible injury to an inattentive passenger and (or) damage to the vehicle, avoid sudden starts, sudden stops, and abrupt turns.
- To help avoid the possibility of losing control of or overturning the vehicle, reduce speed for adverse driving conditions such as wet grass or rough terrain.
- Do not use the vehicle on public roads. It is not designed or intended for street use and should not be licensed for use on public roads.
- Where applicable, obey all local rules concerning off-road vehicles.
- The vehicle should be driven in only specified areas by trained drivers.
- Do not drive while under the influence of alcohol, drugs, or medications.
- To prevent overturning the vehicle, drive slowly in turns.
- Use brakes to reduce speed when coasting downhill.

No one should drive the vehicle without first being instructed in the proper operation and use of the vehicle's controls. An experienced operator should accompany each first-time driver on a test drive before allowing him/her to operate the vehicle alone.

To ensure safe operation of the vehicle, follow exactly and in order, all of the following procedures. Read and understand all instructions prior to driving the vehicle.

## Starting the vehicle

1. Study and understand controls.
2. Read safety warnings located on dash and above pedals.
3. For vehicles with cargo beds: Make sure load is secure.
4. Make sure everyone is seated and holding onto seat hand holds or handrails.
5. Make sure wheels are turned in desired direction and that nothing is in your path.
6. Turn key to the ON position.
7. Select direction by placing the Forward/Reverse handle or switch in desired position (F = forward or R = reverse).
8. Place both hands on the steering wheel.
9. Slowly press accelerator pedal. Release the parking brake.  
vehicle will start to move. As the accelerator pedal is pressed, speed will increase until full speed is reached. **See following WARNING and NOTE.**

### WARNING

- Operator must control vehicle speed when going downhill.
- HuntVe vehicles: “Pedal down” or “pedal up” motor braking may be used to help control speed when going downhill; however, steep terrain or other conditions may require that pedal braking be used in conjunction with motor braking.

## STOPPING THE VEHICLE

### WARNING

- Driving through water may affect the brakes. After driving through water, check effectiveness of the brakes by gently pressing the brake pedal. If the vehicle does not slow down at the normal rate, continue to press the brake pedal until the brakes dry out and normal performance returns.

### CAUTION

- When stopped on a hill, use the brake pedal to hold your position. Do not use the accelerator pedal to hold position.

To stop the vehicle, release the accelerator pedal and press the brake pedal with your right foot until the vehicle comes to a complete stop.

## PARKING AND LEAVING THE VEHICLE

1. After stopping the vehicle, set the parking brake.
2. Turn the key switch to the OFF position and place the Forward/Reverse handle or switch in the NEUTRAL position. Remove the key when the vehicle is not in use.
3. When the Tow/Run switch is in the RUN or ON position, (with the Forward/Reverse switch or key switch in any position), the zero speed detect function will prevent the vehicle from rolling at more than 1 or 3 mph (1.5 or 4.8 km/h) unless the accelerator is pressed. This prevents the possibility of a parked vehicle (with the park brake disengaged) rolling away too fast to be overtaken on foot.

## LOADING AND UNLOADING – BOX BED VEHICLES

### WARNING

- Engage the park brake before loading the vehicle.
- Do not allow riders in the cargo bed.
- Do not exceed the rated capacity of the vehicle. Rated capacity is for level surfaces only.

### WARNING

- Overloading can affect vehicle handling or cause component failure, resulting in loss of control of vehicle and possible severe personal injury.
- Reduce speed and avoid sudden stops when backing up. Failure to do so may cause the vehicle to overturn or flip over backwards.
- Avoid stopping on a hill when loaded. If you must stop on a hill, avoid sudden starts, or rolling backwards and stopping suddenly. Failure to heed this warning may cause vehicle to overturn, possibly resulting in severe personal injury.
- Reduce vehicle load and speed when driving up or down slopes or on uneven terrain.
- Do not load the tailgate. The tailgate should be in the upright position and latched securely while the vehicle is in motion.
- To help avoid shifting the vehicle load and possibly overturning the vehicle, avoid sudden starts, sudden stops, and abrupt turns. Make sure cargo is well-secured.
- The cargo's center of gravity may affect the handling, steering, and braking of the vehicle. When the vehicle is loaded, reduce speed and drive slowly in turns.
- Avoid top-heavy loads. The center of gravity of a load should never exceed 15 inches (38 cm) above the bottom of the cargo bed.
- Unload cargo bed before raising vehicle with a lift, hoist, or jack.

When loading the vehicle, center and secure cargo as far forward as possible in the cargo bed. Do not overload the vehicle. **See the following chart for vehicle capacities.**

**Maximum payload capacity** 500 lb.  
(cargo bed load plus gross trailer weight) (68 kg)

**Maximum vehicle capacity** 1200 lb.  
(cargo bed load, passengers, plus gross trailer weight) (249.5 kg)

150 lb. force

**Trailer tongue weight**

## TOWING WITH THE VEHICLE

### WARNING

- Do not tow a vehicle or trailer on public streets or highways.
- Normal vehicle operating speed should be reduced when towing.
- Extreme caution should be used when towing.
- Total vehicle capacity, including the vehicle load rating and the gross weight of the vehicle or trailer being towed should not exceed the weight previously specified.
- Do not allow riders in the vehicle or trailer being towed.
- Avoid sudden starts, sudden stops, and tight turns when towing.
- Avoid stopping on a hill when towing. If you must stop on a hill, avoid sudden starts or rolling backwards and stopping suddenly. Failure to heed this warning could cause vehicle to overturn, possibly resulting in severe personal injury.

Because towing a vehicle or trailer can have adverse effects on vehicle handling, be especially cautious when towing with a HuntVe vehicle. **See the preceding chart for vehicle capacities (page 15).**

Parking the vehicle with a trailer on a hill should be avoided. If you must park on a hill, apply the brakes and have someone chock the tires of the trailer. Brakes should be released to allow the chocks to absorb the load of the trailer. After the tires have been chocked, engage the park brake.

## TOWING THE VEHICLE

### WARNING

- Do not tow the vehicle on public streets or highways.
- Turn the key switch to the OFF position and place the Forward/Reverse handle or switch in the NEUTRAL position before towing the vehicle.
- Extreme caution should be used when towing any vehicle.
- Do not exceed 5 mph (8 km/h) towing speed.
- Do not allow people in the vehicles being towed.
- Avoid sudden starts, sudden stops, and tight turns when towing.
- Avoid stopping on a hill when towing. If you must stop on a hill, avoid sudden starts or rolling backwards and stopping suddenly. Failure to heed this warning could cause the vehicle to overturn, possibly resulting in severe personal injury.
- Place the Tow/Run switch in TOW position; otherwise, the vehicle will not roll while being towed.



## TRANSPORTING ON A TRAILER

### WARNING

- For use on public roads, the trailer must meet all federal, state, and local requirements such as taillights, brake lights, etc.
- Do not tow a HuntVe vehicle behind a passenger vehicle or truck on a public road unless it is on an approved trailer.
- The vehicle to be towed should be tied securely to the trailer, with the Forward/Reverse handle or switch in the NEUTRAL position, the key switch in the OFF position, and the park brake firmly pressed and locked.
- Do not allow people in the trailer or vehicle being towed.
- Avoid sudden starts, sudden stops, and tight turns when towing.
- When towing on a trailer, normal road speed of the tow vehicle should be reduced.
- Because of the added length of the trailer, use caution when making turns.
- Remove the vehicle windshield and secure the seat bottom before transporting on a trailer.

If the vehicle must be transported over long distances or on public highways, it should be transported on an approved trailer that has the approved load rating of 1800 lb. per vehicle being transported.

**NOTE:** A two-car trailer should be rated at  $2 \times 1800 = 3600$  lb. .

## STORAGE

See General Warnings on page 8.

### WARNING

- Turn the key switch to the OFF position, remove the key, and leave the Forward/Reverse switch in the NEUTRAL position during storage. Place Tow/Run switch in the TOW position. This is to prevent unintentionally starting the vehicle or a fire hazard.
- Do not attempt to charge frozen batteries or batteries with bulged cases. Discard the battery. Frozen batteries (lead acid) can explode.

### CAUTION

- Batteries (Lead Acid) in a low state of charge will freeze at low temperatures.
- To avoid exposing electrical components to moisture and subsequent damage, do not use any type of pressure washing or steam cleaning equipment to wash the vehicle.

## PREPARING THE ELECTRIC VEHICLE FOR EXTENDED STORAGE

1. Unload the vehicle so that the tires are supporting only the weight of the vehicle.

### ***Maintenance***

1. Fully charge batteries. (Lead Acid) **See Charging Batteries on page 27.**
2. Batteries should be clean and free of corrosion. Wash battery racks, tops and terminals of batteries with a solution of baking soda and water (1 cup (237 ml) baking soda per 1 gallon (3.8 L) of water). Rinse solution off batteries. Do not allow this solution to enter the batteries. Be sure terminals are tight. Let the terminals dry and then coat them with Battery Terminal Protector Spray.
3. Store vehicle in a cool, dry place. This will minimize battery self-discharge.
4. Adjust tires to recommended tire pressure. **See Specifications on page 31.**
5. Perform semiannual periodic lubrication. **See Periodic Lubrication Schedule on page 20.**
6. Thoroughly clean front body, rear body, seats, battery compartment, and underside of vehicle.
7. Do not engage the park brake. Chock the wheels to prevent the vehicle from rolling.
8. Keep batteries fully charged during storage.

- **Chargers:** Leave Charger plugged in during storage. The charger will automatically activate when necessary. If charger cannot remain plugged in, or AC power will not be available during extended storage, Turn the Tow Switch off and disconnect a battery cable.

### **CAUTION**

- **Be sure to check the batteries and charger monthly to maintain correct battery water level and to ensure the charger is operating correctly during storage.**

## RETURNING THE STORED ELECTRIC VEHICLE TO SERVICE

1. If necessary, with Tow Switch off connect batteries and tighten terminals to 110 in-lb (12.4 N·m).
2. Fully charge batteries (Lead Acid).
3. Adjust tires to recommended tire pressure. **See Specifications –on page 31.**
4. Perform the Pre-Operation and Daily Safety Checklist on page 16 and the Performance Inspection on page 16.

# MAINTENANCE

## See General Warnings on page 9.

To ensure trouble-free vehicle performance, it is very important to follow an established preventive maintenance program. Regular and consistent vehicle maintenance can prevent vehicle downtime and expensive repairs that can result from neglect. Use the Pre-Operation and Daily Safety Checklist on page 14, the Performance Inspection on page 14, and the following Periodic Service Schedule and Periodic Lubrication Schedule to keep the vehicle in proper working condition.

Any vehicle not functioning correctly should be removed from use until it is properly repaired. This will prevent further damage to the vehicle and avoid the possibility of injury due to unsafe conditions.

Contact your local HuntVe dealer to perform all repairs and semiannual and annual periodic service.

## Periodic Service Schedule

### WARNING

- ❑ **If any problems are found during scheduled inspection or service, do not operate the vehicle until repairs are made. Failure to make necessary repairs could result in fire, property damage, severe personal injury, or death.**
- ❑ **Do not wear loose clothing or jewelry, such as rings, watches, chains, etc., when servicing the vehicle.**
- ❑ **Turn key switch to the OFF position, remove the key, place the Forward/Reverse handle in the NEUTRAL position, and chock wheels prior to servicing.**
- ❑ **Hot! Do not attempt to service hot motor or resistors. Attempting to do so could cause severe burns.**
- ❑ **Do not work on the vehicle power train or under the cargo bed when it is loaded.**

## PERIODIC SERVICE SCHEDULE

### See General Warnings on page 8.

### WARNING

- **Service, repairs, and adjustments must be made per instructions in the maintenance and service manual.**

***NOTE: If the vehicle is constantly subjected to heavy use or severe operating conditions, the preventive maintenance procedure should be performed more often than recommended in the periodic service and lubrication schedules.***

*Both the Periodic Service Schedule and Periodic Lubrication Schedule must be followed to keep vehicle in optimum operating condition.*

<b>PERIODIC SERVICE SCHEDULE</b>		
<b>REGULAR INTERVAL</b>	<b>SERVICE</b>	
<b>Daily service by owner</b>	Pre-Operation and Daily Safety Checklist	<b>See Pre-Operation and Daily Safety Checklist on page 14.</b>
	Performance Inspection	<b>See Performance Inspection on page 15.</b>
	Batteries	Charge batteries (after each daily use only).
<b>Weekly service by owner</b>	Batteries	Check electrolyte level. Add water if necessary. <b>See page 25.</b>
<b>Monthly service by owner or trained technician</b>	Batteries	Wash battery tops and clean terminals with baking soda/water solution.
	Tires	Check air pressure and adjust if necessary.
	General vehicle	Wash battery compartment and underside of vehicle.
<b>Semiannual service by trained technician only(every 50 hours)</b>	Brake system	Check brake pads; replace if necessary.
		Lubricate brake slides per Lubrication Schedule.
		Check brake lines for damage; replace if necessary.
	Electrical wiring and connections	Check for tightness and damage.
	Forward/Reverse switch	Check condition of contacts and wire connections. Make sure connections are tight.
	Front wheel alignment and camber	Check and adjust as required. <b>See</b>
	Electronic Throttle	Check for loose hardware, cracks and other damage.
<b>Annual service by trained technician only(every 100 hours)</b>	Batteries	If batteries are not performing as expected.

## **WARNING**

- **If any problems are found during scheduled inspection or service, do not operate the vehicle until repairs are made. Failure to make necessary repairs could result in fire, property damage, severe personal injury, or death.**

## PERIODIC LUBRICATION SCHEDULE

<b>PERIODIC LUBRICATION SCHEDULE</b>			
<b>REGULAR INTERVAL</b>	<b>SERVICE</b>	<b>LUBRICATION POINTS</b>	<b>RECOMMENDED LUBRICANT</b>
<b>By owner or trained technician (every 200 miles)</b>	Brake pedal shaft bearings		Dry Moly Lube
	Brake linkage and pivots		Dry Moly Lube
	Accelerator pivot rod supports		Dry Moly Lube
	Charger receptacle (all vehicles). Forward/Reverse switch contacts*		WD-40
	Brake slides		Dry Moly Lube
	suspension (8 fittings)		Chassis Lube – EP NLGI Grade 2
<b>By owner or trained technician (Every 500 Miles)</b>	Replace transaxle Fluid Drain from bottom plug Refill trough vent on top		22 oz. (0.67 liters) 22 oz. (0.67 liters) SAE 85-90 WT. API Class SE, SF, or SG Oil (or higher)

## VEHICLE CONTROLLER

The electric vehicle is equipped with a solid state speed controller. In order to properly service and maintain the solid state controller vehicle, it is necessary to understand the electrical circuitry and the functions of all components in both systems. Therefore, if any repair or servicing needs to be performed, we recommend that it be performed by an authorized HuntVe dealer using HuntVe OEM parts. Not understanding or being trained how to properly handle controllers can damage controllers and require replacement.

## BATTERIES

See General Warnings on page 8.

### DANGER

- **Battery (Lead Acid) – Explosive gases! Do not smoke. Keep sparks and flames away from the vehicle and service area. Ventilate when charging or operating vehicle in an enclosed area. Wear a full face shield and rubber gloves when working on or near batteries.**
- **Charge batteries in a well-ventilated area only. Batteries emit hydrogen while being charged. Hydrogen is an explosive gas and must never exceed a level of 2% of the air.**
- **Battery – Poison! Contains acid! Causes severe burns. Avoid contact with skin, eyes, or clothing. Antidotes:**
  - **External: Flush with water. Call a physician immediately.**
  - **Internal: Drink large quantities of milk or water followed with milk of magnesia or vegetable oil. Call a physician immediately.**
  - **Eyes: Flush with water for 15 minutes. Call a physician immediately.**

### WARNING

- **Wear safety glasses or approved eye protection when servicing the vehicle or battery charger. Wear a full face shield and rubber gloves when working on or near batteries.**
- **Use insulated tools when working near batteries or electrical connections. Use extreme caution to avoid shorting of components or wiring.**

### CAUTION

- **On all vehicles, turn off all accessories before charging batteries.**

**NOTE:** *Recycle or dispose of discarded batteries in accordance with local, state, and federal regulations.*

HuntVe electric vehicles use both deep-cycle lead acid batteries and AGM batteries. Automotive batteries should never be used.

New Deep Cycle Lead Acid batteries will not deliver their full capabilities until they have been discharged and recharged 20 to 50 times. To obtain the maximum service life from new batteries, **restrict vehicles with new batteries to 50% discharge for the first 10-12 charge cycles.** Batteries should be fully charged before first use of new vehicle, before first use of a vehicle after storage, and before releasing vehicle for use each day.

## DEEP CYCLE LEAD ACID BATTERY CARE

To keep batteries in good working condition, follow this maintenance program on a regular basis:

### Batteries

1. The batteries should be kept clean and free of corrosion. Wash tops and terminals of batteries with a solution of baking soda and water (1 cup (237 mL) baking soda per gallon (3.8 L) of water). Rinse solution off of the batteries. Do not allow this solution to enter the battery. Be sure terminals are tight. Let the terminals dry and then coat with Battery Terminal Protector Spray. **See following NOTE.**

**NOTE:** Dispose of waste water properly.

2. The electrolyte level in the batteries should be checked weekly (**Figure 14**). Add water only after charging unless the electrolyte level is below the top of the plates. In this case, add just enough water to cover the plates, charge and then check the level again. Never charge batteries if plates are exposed above electrolyte level. For best battery life, add only distilled water. **See following CAUTION and NOTE.**

### CAUTION

- **Do not overfill the batteries. NOTE:** A battery watering gun or bottle is available at many auto parts dealers.

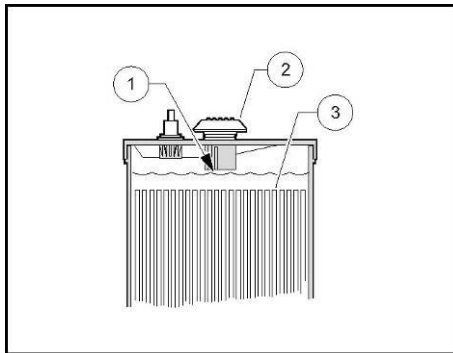

Figure 14 Battery Electrolyte Level

1. Level Indicator 2. Cap 3. Plates Electrolyte level at least 1/2 inch (13 MM) above plates or to level indicator Fig 14.
3. The hold-down straps should be tight enough so that the batteries do not move while the vehicle is in motion, but not so tight as to crack or buckle the battery case. Tighten hold-down retaining nuts to 40 inlb (4.5 N·m). The terminal connections should be clean and tight, and any worn insulation or frayed wires should be replaced. Tighten battery terminals to 110 in-lb (12.4 N·m). **See following WARNING.**

### WARNING

- If battery wire terminals are damaged or corroded, replace or clean them as necessary. Failure to do so may result in a fire hazard.
4. After use, the batteries should be placed on charge. The batteries should never be left discharged any longer than absolutely necessary (do not leave discharged overnight).

## AGM (Absorbed Glass Mat) BATTERY CARE

To keep batteries in good working condition, follow this maintenance program on a regular basis:

### *Batteries*

1. The AGM battery is sealed and does not need the fluid levels checked.
2. The batteries should be kept clean. Wash tops and terminals of batteries with a solution of baking soda and water (1 cup (237 mL) baking soda per gallon (3.8 L) of water). Rinse solution off of the batteries. Be sure terminals are tight. Let the terminals dry and then coat with Battery Terminal Protector Spray. **See following NOTE.**

**NOTE:** *Dispose of waste water properly.*

2. The hold-down straps should be tight enough so that the batteries do not move while the vehicle is in motion, but not so tight as to crack or buckle the battery case. Tighten hold-down retaining nuts to 40 in-lb (4.5 N·m). The terminal connections should be clean and tight, and any worn insulation or frayed wires should be replaced. Tighten battery terminals to 110 in-lb (12.4 N·m). **See following WARNING.**

### **WARNING**

- If battery wire terminals are damaged replace or clean them as necessary. Failure to do so may result in a fire hazard.
3. After use, the batteries should be placed on charge. The batteries should never be left discharged any longer than absolutely necessary (do not leave discharged overnight). If extended storage (1 week or more) the vehicle Run/Tow switch under the dash above the accelerator (see image below) needs to be placed in the Tow position.

**Batteries that are left in a discharged condition may be damaged beyond repair voiding any stated warranty. AGM batteries are particular susceptible to damage from a low state of charge and many times will not recover and function if completely discharged.**



## BATTERY CHARGER

### DANGER

- With Deep Cycle flooded batteries the charging area must be ventilated. Hydrogen level in the air must never exceed 2%. The total volume of air in the charging area must be changed five times per hour. Exhaust fans should be located at the highest point of the roof. Contact a local HVAC engineer.
- Do not charge the vehicle batteries with the vehicle covered or enclosed. Any enclosure or cover should be removed or unzipped and pulled back when batteries are being charged. An accumulation of hydrogen gas could result in an explosion.

### WARNING

- Only trained technicians should repair or service the charger. Contact your nearest HuntVe dealer.
- Each charger should have its own dedicated 15 or 20 ampere separately protected (circuit breaker or fuse) single phase branch circuit, in accordance with all applicable electrical codes for the location.
- Connect the charger AC supply cord to a properly grounded, three-wire outlet of the proper voltage and frequency as shown on the charger.
- Do not use an adapter to plug the charger with a three-prong plug into a two-prong outlet. Improper connection of the equipment-grounding conductor can result in a fire or an electrical shock.
- An extension cord or electrical outlet must accept a three-prong plug. Extension cord should be a three-wire No. 12 AWG (American Wire Gauge) or No. 14 SWG (British Standard Wire Gauge), and be as short as possible. The use of improper extension cord could result in fire or an electrical shock.
- Do not operate the charger if it has received a sharp blow, was dropped, or otherwise damaged in any way.
- Have worn, cut, or damaged power cords or wires replaced immediately.
- Do not use near fuels, grain dust, solvents, thinners, or other flammables. Chargers can ignite flammable materials and vapors.
- Do not expose to rain or any liquid. Keep the charger dry.
- Never push objects of any kind into the charger through cabinet slots. They may touch dangerous voltage points or cause an electrical short circuit that could result in fire or electrical shock.
- Do not connect a stationary charger to the receptacle if the charger cord, plug, or the vehicle receptacle is broken, damaged, or does not make a good electrical connection. Fire or personal injury can result. Have a qualified technician replace the parts.
- When the charger is on, the charger DC cord may be disconnected from the vehicle receptacle slowly. Jerking or pulling the DC cord out quickly could cause arcing and burning that could damage the plug and receptacle and could cause batteries to explode.
- Do not block or cover the charger ventilation slots. The slots provide ventilation and protect the charger from overheating.
- Do not allow clothing, blankets, or other material to cover the charger.
- Do not allow the charger to operate for more than 30 minutes at 19 or more amperes.
- Install surge arrestors on incoming AC power lines. Surge arrestors will help protect electrical components in the charger and on the vehicle from all but direct or close lightning strikes.

## **Battery Charger Storage Feature**

***NOTE: Because the charger has a storage charge feature that automatically checks and recharges the batteries as necessary every day, the charger can remain plugged to the vehicle throughout the storage period and the vehicle tow switch should be placed in the Tow position.***

Each electric vehicle is supplied with a fully automatic battery charger as standard equipment. The AC cord to each charger is to be connected to a source capable of supplying 15 amperes minimum per charger.

To reduce the risk of electric shock, the battery charger must be grounded. The charger is equipped with an AC electric cord having an equipment-grounding conductor and a grounding type plug. The AC plug must be connected to an appropriate receptacle that is properly installed and grounded in accordance with the National Electrical Code and all local codes and ordinances. See the owner's manual supplied with the charger for specific operating instructions before using the charger.

The use of an extension cord with the charger should be avoided. If an extension cord must be used, use a three-conductor no. 12 AWG (American Wire Gauge) or no. 14 SWG (British Standard Wire Gauge), heavy-duty cord with ground, properly wired and in good electrical condition. Keep it as short as possible (no more than 25 feet (3.7 m)). Place all cords so they will not be stepped on, tripped over, or otherwise subject to damage or stress.

Ensure that the charger ventilation slots are unobstructed and that there is adequate ventilation.

### **WARNING**

- ❑ **Do not use charger if cords or charging receptacle damaged in any way.**
- ❑ **Do not use any other charger than the factory charger that came with the vehicle.**

## CHARGING BATTERIES

### WARNING

- Be sure all wire connections at the receptacle and the fuse link are clean and tight.
- Do not rock or bend the plug. To connect the charger plug to the vehicle receptacle, grasp the plug handle and push the plug straight into the receptacle (Figure 15, Page 31).
- Do not pull on the DC cord (Figure 16, Page 31). Do not twist rock or bend the plug. To disconnect the charger plug from the vehicle receptacle, grasp the plug by the handle and pull the plug straight out of the receptacle.
- Do not connect a charger to the receptacle if the charger cord, plug, or the vehicle receptacle is broken, damaged in any manner, or does not make a good electrical connection. Fire or personal injury can result. Have it replaced by a qualified service person immediately.
- Failure to follow these instructions could result in damage to the charger cord, the plug, and (or) the vehicle receptacle.
- Do not use a charger if:
  - The plug is too loose or does not make a good connection.
  - The plug and receptacle feel hotter than normal during charge.
- The plug pins or receptacle contacts are bent or corroded.
- The plug, receptacle, or cords are cut, worn, have any exposed wires or are damaged in anyway.
- Using the charger with any of the above symptoms could result in a fire, property damage, personal injury, or death.

***NOTE: When temperatures fall below 65 °F (18.3 °C), batteries charged in unheated areas should be placed on charge as soon as possible after use. Batteries are warmest immediately after use, and cold batteries require more time to fully charge.***

Insert the charger DC plug into the vehicle receptacle. The charger will turn on two to ten seconds later (Figure 15).

When inserting the DC plug, align the raised guide on the plug with the guide slot in the receptacle and push straight in slowly.

Battery chargers made by other manufacturers may not be compatible.

As long as the charger is allowed to shut off by itself, the batteries will be fully charged. Overcharging and undercharging will normally be prevented.

Batteries should be put on charge even if they have been used for only a short period. The charger is automatic and will turn off when batteries are fully charged. If the charger does not seem to be operating properly, or if the batteries seem weak, contact your local HuntVe dealer.

## PLUG AND RECEPTACLE

The charger cord, plug, and receptacle are wear items and should be inspected daily. Visually inspect them for cracks, loose connections, and frayed wiring; they must be replaced when worn or damaged. If charger plug or receptacle show signs of corrosion or the plug is difficult to insert or remove the receptacle contacts and plug terminals should be cleaned with a good electrical contact cleaner or lightly sprayed with WD-40<sup>®</sup> brand spray lubricant. The plug should then be inserted and removed several times to ensure ease of insertion, ease of removal, and good electrical contact.

## CLEANING THE VEHICLE

HuntVe vehicles are equipped with ArmorFlex<sup>®</sup> front and rear bodies. Use only commercially available automotive cleaners with a sponge or soft cloth for normal cleaning. A garden hose at normal residential water pressure is adequate.

The use of any type of pressure washing or steam cleaning system is not recommended. Such a process (especially if the vehicle has an ArmorFlex rear body that is removed) will expose electrical components to moisture. Moisture entering electrical components can result in water damage and subsequent component failure.

Use non-abrasive wax products. Battery acid, fertilizers, tars, asphalt, creosote, paint, or chewing gum should be removed immediately to prevent possible stains.

### *Accessories*

The seats of the vehicle will last longer with proper cleaning. Use a solution of 10% liquid soap and warm water applied with a soft cloth. For imbedded dirt, a soft bristle brush may be used. For heavy soiling, difficult stains or scratches, blemishes, or other body damage, see Section 4 of the appropriate maintenance and service manual.

**NOTE:** *Dispose of waste water properly.*

## ACCESSORIES

There is a complete line of accessory equipment available from HuntVe and our dealers. You can obtain the name and phone number of your closest HuntVe contact by visiting our web site at [www.HuntVe.com](http://www.HuntVe.com) and clicking the "*Dealer Locator*" link.

Care should be taken that these accessories are properly installed by trained technicians, and that they are used in the manner for which they were designed. **See following WARNING.**

### WARNING

- **Tinted windshields and weather-proof enclosures will not protect occupants from flying objects.**

## SUBSEQUENT OWNER REGISTRATION

In the event a vehicle is bought as a used vehicle, we strongly urge the new owner to register the vehicle with HuntVe. This will enable us to contact you if the need arises. Please send your name, address, and serial number(s) of the vehicle(s) by fax or email to Martex Global Enterprise L.L.C. fax 888.271.2815 email [info@huntve.com](mailto:info@huntve.com).

## SPECIFICATIONS – 2-PASSENGER AND 4-PASSENGER

SPECIFICATIONS	2-PASSENGER	4 -PASSENGER
<b>POWER SOURCE</b>		
<b>Drive motor:</b> Direct drive, 48/64/72volts DC, shunt-wound, 18 hp front – 20 hp rear	•	•
<b>Transaxle:</b> Double reduction helical gear with 12.3:1 direct drive axle	•	•
<b>Electrical system:</b> 48/64/72 volts DC	•	•
<b>Batteries:</b> High capacity, deep cycle, or AGM	•	•
<b>Charger:</b> Automatic, 48/64/72volt; UL and CSA listed	•	•
<b>STEERING/SUSPENSION/BRAKES</b>		
<b>Steering:</b> Self-adjusting rack and pinion	•	•
<b>Front Suspension:</b> Tapered double a-arm with dual coil over hydraulic shocks	•	•
<b>Rear Suspension:</b> Tapered double a-arm with dual coil over hydraulic shocks	•	•
<b>Brakes:</b> 4 wheel hydraulic – 4 wheel disc brakes with lever pull park brake	•	•
<b>BODY/CHASSIS</b>		
<b>Frame/Chassis:</b> Powder coated heavy duty steel	•	•
<b>Front and rear body:</b> ArmorFlex®	•	•
<b>Body finish:</b> Water transfer camo and solid colors	•	•
<b>Tires:</b> Rough terrain with 12" steel/aluminum wheels	•	•
<b>DIMENSIONS/WEIGHT</b>		
<b>Overall length</b>	114 in. (232 cm)	137 in. (348 cm)
<b>Overall width</b>	57 in. (145 cm)	57 in. (145 cm)
<b>Overall height (with canopy)</b>	76 in. (193 cm)	86 in. (196 cm)
<b>Wheelbase</b>	75 in. (190 cm)	101 in. (257 cm)
<b>Ground clearance</b>	11.75 in. (30 cm)	11.75 in. (30 cm)
<b>Weight (without batteries)</b> 2 passenger 4 passenger crew	1175 lb.	1400lb.
<b>Forward speed</b>	18 - 25 mph	
<b>Curb clearance circle (diameter)</b>	23 ft.	
<b>Standard seating capacity (Box bed vehicles)</b>	2	
<b>Standard seating capacity (Four-passenger vehicle)</b>	4	
<b>LIQUID CAPACITIES</b>		
<b>Transaxle</b>	22 oz. 85/90 gear lube (0.67 liters)	
<b>TIRE PRESSURE</b>		
<b>Front and rear: Off-road tread</b>	14-18 psi (0.96-1.24 Bars)	

# HUNTVE<sup>®</sup> LIMITED ONE YEAR WARRANTY

## 1. WARRANTY:

Martex Global Enterprise L.L.C., ("HUNTVE") hereby warrants to the Purchaser that its Vehicle purchased from HUNTVE<sup>™</sup> shall be free from defects in material and workmanship under normal use and service for the periods stated below, subject to the provisions, limitations and exclusions contained in this limited warranty. **This warranty applies to original Purchaser owner only and is nontransferable.**

**LIMITED ONE YEAR WARRANTY:** All original equipment including battery charger and solid state speed controller, supplied by HUNTVE<sup>™</sup> are warranted with respect to parts and labor against defects in material and workmanship for a period of one year from the date of purchase.

This limited warranty covers material, workmanship and repair labor cost listed above for the period specified. Such repair labor shall be performed only by HUNTVE, its authorized distributors or dealers, or a service agency approved by HUNTVE.

IF THE WARRANTY REGISTRATION FORM IS NOT COMPLETED AND RETURNED TO HUNTVE AT THE TIME OF THE ORIGINAL RETAIL SALE, PURCHASER MUST PROVIDE PROOF OF DATE OF PURCHASE WITH ANY WARRANTY CLAIM.

## 2. EXCLUSIONS:

Excluded from any HUNTVE warranty are all fuses, decals (except safety decals), light bulbs, lubricants, trim pieces, seats, routine wear items such as the charger plug and receptacle, brake shoes, CV boots, belts, brushes, bushings, drive buttons, mats and pads, maintenance adjustments, cosmetic deterioration, and items which deteriorate or fail due to exposure or ordinary wear and tear. Also excluded from any HUNTVE warranty is damage to a vehicle or component resulting from a cause other than a defect including unreasonable or unintended strain or use, improper installation of accessories, installation of parts or accessories that are not original equipment, overloading, accident, alteration, abuse or neglect.

Transportation expenses for warranty services are also excluded from this warranty.

## 3. VOIDING OF WARRANTY:

THIS AND ANY OTHER WARRANTY SHALL BE VOID IF THE VEHICLE IS ABUSED OR USED IN AN UNINTENDED MANNER OR SHOWS INDICATIONS THAT IT HAS BEEN ALTERED IN ANY WAY, INCLUDING, BUT NOT LIMITED TO, MODIFICATION OF THE SPEED GOVERNOR, BRAKING SYSTEM, STEERING, TRANSAXLE, OR OTHER OPERATING SYSTEMS OF THE VEHICLE TO CAUSE IT TO PERFORM OUTSIDE HUNTVE SPECIFICATIONS. THE WARRANTY IS LIKEWISE VOID IF THE VEHICLE INVOLVED SHOWS INDICATIONS THAT REASONABLE OR NECESSARY MAINTENANCE AS OUTLINED IN THE OWNER'S MANUAL AND MAINTENANCE AND SERVICE MANUAL WAS NOT PERFORMED AT THE TIME AND IN THE MANNER SPECIFIED IN SUCH MANUALS.

## 4. SOLE REMEDY:

HuntVe's liability under this limited warranty or in any action whether based upon warranty, contract, negligence, strict product liability, or otherwise, shall be the repair or replacement, at HuntVe's option, of the vehicle or component thereof that HUNTVE deems to be defective. Replacement shall mean furnishing, during the applicable limited warranty period, a factory-reconditioned vehicle or component thereof that is identical or reasonably equivalent to the warranted product or component at no cost to the purchaser. Repair shall mean remedying a defect in the vehicle or component thereof at no cost to the purchaser during the applicable limited warranty period. If HUNTVE elects to repair the vehicle, it may provide factory-reconditioned parts or components. All parts and components replaced under warranty shall become the property of HUNTVE.

**5. HOW TO MAKE A WARRANTY CLAIM:**

To make a warranty claim under this limited warranty, you must present the vehicle or defective component to an authorized HUNTVE dealer or send the defective component; freight prepaid, to WARRANTY SERVICES, Martex Global Enterprise L.L.C. 808 E Mason St Fort Worth, TX 76110

**6. DISCLAIMER:**

**THIS LIMITED WARRANTY IS EXCLUSIVE. HUNTVE MAKES NO OTHER WARRANTY OF ANY KIND, EXPRESSED OR IMPLIED. ANY IMPLIED WARRANTIES OF MERCHANTABILITY OR FITNESS FOR A PARTICULAR PURPOSE WHICH EXCEED THE OBLIGATIONS OR TIME LIMITS STATED IN THIS WARRANTY ARE HEREBY DISCLAIMED BY HUNTVE AND EXCLUDED FROM THIS WARRANTY. THE PURCHASER AND HUNTVE EXPRESSLY AGREE THAT THE REMEDY OF THE REPLACEMENT OR REPAIR OF THE DEFECTIVE VEHICLE OR COMPONENT THEREOF IS THE SOLE REMEDY OF THE PURCHASER. HUNTVE MAKES NO OTHER REPRESENTATION OR WARRANTY OF ANY KIND, AND NO REPRESENTATIVE, EMPLOYEE, DISTRIBUTOR OR DEALER OF HUNTVE HAS THE AUTHORITY TO MAKE OR IMPLY ANY REPRESENTATION, PROMISE OR AGREEMENT, WHICH IN ANY WAY VARIES THE TERMS OF THIS WARRANTY.**

**7. NO CONSEQUENTIAL DAMAGES:**

**IN NO EVENT SHALL HUNTVE BE LIABLE FOR ANY INCIDENTAL OR CONSEQUENTIAL DAMAGES INCLUDING, BUT NOT LIMITED TO, LOSS RELATED TO PROPERTY OTHER THAN THE VEHICLE, LOSS OF USE, LOSS OF TIME, INCONVENIENCE, OR ANY OTHER ECONOMIC LOSS.**

Some states allow neither limitation on the duration of an implied warranty nor exclusions or limitation of incidental or consequential damages. Therefore, the above limitations or exclusions may not apply to you.

This warranty gives you specific legal rights, and you may also have other rights, which vary from state to state.

**8. INFORMATION:**

For further information contact WARRANTY SERVICES, Martex Global Enterprise LLC, 808 E. Mason St, Fort Worth, TX 76110 ph: 888.554.5953

**9. WARNING:**

Any modification or alteration of any vehicle beyond factory specifications, including those that affect the weight distribution, stability, or speed of the vehicle, can cause serious personal injury or death.

**Publication Part Number HV1003**

**Martex Global Enterprise LLC**

Fort Worth, TX 76110  
USA

<b>Web</b>	www.HuntVe.com
<b>Phone</b>	1.888.554.5953
<b>Fax</b>	1.888.271.2815





## HuntVe Speedometer Button Function WARNING

All Adjustments will require the key switch to be in the on position. Make sure the vehicle forward-reverse switch is in the neutral position.

### 24 Hour Clock Adjustment

1. While in the normal display status press the SET button for at least 3 seconds and release when the hour screen displays, and the hour is flashing.
2. Press the ADJ button to change the hour.
3. Press the SET button until the minute number is flashing. 4. Press the ADJ button
5. The normal display will return after 5 seconds of no activity.

### KM/MPH Adjustment

1. While in the normal display status press the SET button for at least 3 seconds and release when the hour screen hour is flashing.
2. Press the SET button until the km/mph display is flashing. 3. Press the ADJ button to change to km or mph.
4. The normal display will return after 5 seconds of no activity.

### Reset Trip Mileage.

1. Press and hold the ADJ button until the trip mileage clears. 2. The normal display will return after 5 seconds of no activity.

### Adjust the Screen Brightness

1. Press the ADJ button and release.
2. The screen brightness number will display. The number 1 is the darkest and 5 is the lightest. 3. Press and hold the ADJ button to change the number.
4. Press the ADJ button to return to the normal display.
5. The normal display will return after 5 seconds of no activity.

## HuntVe Dash Display



The dash display provides the vehicle driver with real time battery voltage condition:

1. With the power demand from the motors
2. With the traction resistance
3. With the throttle demand

This display works like a fuel Mileage feature - the higher you keep the battery voltage the longer the range you will get.

### 2016 and up Fuse Box Diagram

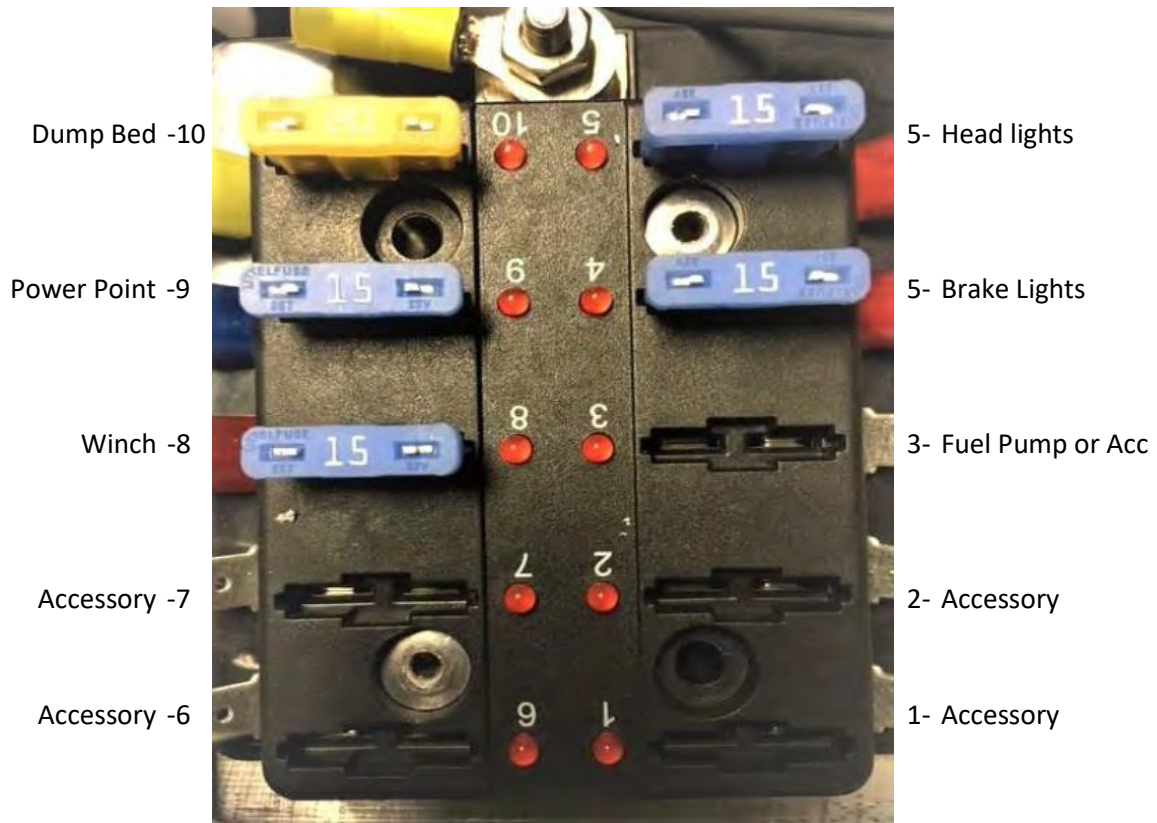



# PRO Charging Systems

## Safety, Installation and Operating Instructions

*Instructions importantes concernant la sécurité*

Manual for the following Battery Fuel Gauge models:

BFGOV12V, BFGOV24V, BFGOV36V, BFGOV48V, BFGOV64V and BFGOV72V



123015-70326

### IMPORTANT NOTICE:

Please save and read these safety, operating and installation instructions before installing or using your Pro Charging Systems (PCS) product. Contact technical support at PCS with any product, installation, or service questions (800.742.2740).

Pro Charging Systems, LLC  
LaVergne, TN 37086-3539

## INSTRUCTIONS FOR THE FOLLOWING BATTERY PACK CONFIGURATIONS:

Model	Description	Weight	Size	Sample Battery Configuration
BFG 12V	Battery Fuel Gauge	8 oz.	0.35"H x 3.85"W x 2.40"L	12V System Configuration - 1-12V Battery, 2-6V Batteries
BFG 24V	Battery Fuel Gauge	8 oz.	0.35"H x 3.85"W x 2.40"L	24V System Configuration - 2-12V Batteries, 4-6V Batteries
BFG 36V	Battery Fuel Gauge	8 oz.	0.35"H x 3.85"W x 2.40"L	36V System Configuration - 3-12V Batteries, 6-6V Batteries
BFG 48V	Battery Fuel Gauge	8 oz.	0.35"H x 3.85"W x 2.40"L	48V System Configuration - 4-12V Batteries, 8-6V Batteries, 6-8V Batteries
BFG 64V	Battery Fuel Gauge	8 oz.	0.35"H x 3.85"W x 2.40"L	64V System Configuration - 8-8V Batteries
BFG 72V	Battery Fuel Gauge	8 oz.	0.35"H x 3.85"W x 2.40"L	72V System Configuration - 6-12V Batteries, 9-8V Batteries, 12-6V Batteries

### TABLE OF CONTENTS

Important Safety Instructions.....	Pages 2-3
Installation and Preparation .....	Page 4
General Operation .....	Pages 4-6
Battery Fuel Gauge Indications.....	Page 7
Troubleshooting .....	Page 7-8
Limited Warranty Information.....	Page 8

## IMPORTANT SAFETY INSTRUCTIONS

### *INSTRUCTIONS IMPORTANTES CONCERNANT LA SÉCURITÉ*

**SAVE THESE INSTRUCTIONS.** This manual contains important safety and operating instructions for future reference.

*CONSERVER CES INSTRUCTIONS. CE MANUEL CONTIENT DES INSTRUCTIONS IMPORTANTES CONCERNANT LA SÉCURITÉ ET LE FONCTIONNEMENT.*

**Understand and relate the Hazard Levels and Signal Words utilized in this manual with the following definitions:**



This symbol means: Immediate hazards, which will result in severe personal injury or death.



This symbol means: Hazards or unsafe practices, which could result in severe personal injury or death.



This symbol means: Hazards or unsafe practices, which may result in minor personal injury, product or property damage.



This symbol means **BE ALERT!** Your safety, or the safety of others, is involved!

## PERSONAL SAFETY PRECAUTIONS



**Always read all instructions before using your product!**

- 1. Wear complete eye protection and clothing protection.** Avoid touching eyes while working near battery. Have plenty of fresh water and soap nearby in case battery acid contacts skin, clothing, eyes, or other surfaces. If battery acid contacts skin or clothing, wash immediately with soap and water. If acid enters eye, immediately flood eye with running cold water for at least 10 minutes and seek medical attention promptly.
- 2. Dress properly.** Wear protective, electrically nonconductive clothes and nonskid footwear. Remove personal metal items such as rings, bracelets, necklaces, and watches when working with a lead-acid battery. A lead-acid battery can produce a short-circuit current high enough to weld a ring or the like to metal, causing a severe burn. Wear restrictive hair covering to contain long hair.
- 3. Avoid working alone.** Be sure someone is within range of your voice or close enough to come to your aid when you work near a lead-acid battery.
- 4. Stay alert.** Watch what you are doing, and use common sense. Do not operate any equipment when you are tired.
- 5. Keep children away.** Children must never be allowed in the work area. Do not let them handle machines, tools, battery chargers, or extension cords.
- 6. Keep work area clean.** Cluttered areas invite injuries.
- 7. Observe work area conditions.** NEVER smoke or allow a spark or flame in the vicinity of battery or engine. Don't expose to rain. Keep work area well lit.
- 8. Do not overreach.** Keep proper footing and balance at all times. Do not reach over or across electrical cables or frames.
- 9. Avoid electrical shock.** To reduce risk of electrical shock, unplug charger from outlet before attempting any maintenance or cleaning.
- 10. Do not operate product with damaged electrical wiring or connections.** If damaged, replace the electrical wiring or connections immediately.
- 11. Store idle equipment.** When not in use, store equipment in a dry location to inhibit rust. Always lock up tools and equipment and keep out of reach of children.
- 12. Maintain battery fuel gauge with care.** Inspect periodically and, if it has received a sharp blow, been dropped, or otherwise damaged in any way, have it repaired by an authorized technician. Do not disassemble battery fuel gauge; contact PCS technical support when service or repair is required (800.742.2740). Incorrect reassembly may result in risk of electrical shock or fire.
- 13. Check for damaged parts.** Before using any PCS product, carefully check any part that appears damaged to determine that it will operate properly and perform its intended function. Check for broken parts and any other condition that may affect proper operation. Any part that is damaged should be properly repaired or replaced by a qualified technician. Do not use the product if any part does not operate properly.
- 14. Replacement parts and accessories.** When maintaining, only use accessories intended for use with this product. Approved accessories are available from Pro Charging Systems (800.742.2740).

## SAVE THESE INSTRUCTIONS!

### INSTALLATION AND PREPARATION



To reduce risk of battery explosion, follow these instructions, those published by the battery manufacturer, and by the manufacturer of any equipment that you intend to use in the vicinity of battery. Review all cautionary markings on these products and on the engine.

*Pour réduire le risque d'explosion, lire ces instructions et celles qui figurent sur la batterie.*

### GENERAL OPERATION



Use the Battery Fuel Gauge for a LEAD-ACID (lead acid, sealed lead acid, gel cell and AGM) batteries only.

*Utiliser le chargeur pour charger une batterie au plomb uniquement*



Be extra cautious to reduce risk of dropping a metal tool onto battery. It might cause a spark or short-circuit a battery or other electrical part, possibly resulting in an explosion. If damaged, contact PCS (800.742.2740).



Never smoke or allow an open spark or flame in the vicinity of the battery or engine.

*Ne jamais fumer près de la batterie ou du moteur et éviter toute étincelle ou flamme nue à proximité de ces dernie.*



Working in the vicinity of a lead-acid battery is dangerous. Batteries generate explosive gases during normal operation. For this reason it is of the utmost importance that prior to each use of your charger, you read and follow the instructions provided exactly.

*Il est dangereux de travailler a proximité d'une batterie au plomb. Les batteries produisent des gaz explosifs en service normal. Il est aussi important de toujours relire les instructions avant d'utiliser le chargeur et de les suivre à la lettre.*

### INSTALLATION:

**Below are the simple steps for installing the Battery Fuel Gauge**

**A Template is provided in order to determine the location of the mounting holes.**

Step 1 - After determining the location for the Gauge, drill the necessary holes to allow for installation and feed the wiring to the battery area.

Step 2 - Check the battery pack with a volt meter to determine which two posts provide the entire battery pack voltage.

Step 3 - The cable leading from the battery pack to the Battery Fuel Gauge comes in two parts. Connect the part with the ring terminals to the batteries first.

Step 4 – After confirming that the connections to the battery pack are correct, “mate” that cable with the cable that comes from the gauge using the JST Connector Tab and housing that are already attached to the cables.

Once you connect your PCS Battery Fuel Gauge, the gauge will begin working automatically. State of charge will be displayed by illumination of the Light Emitting Diodes (LEDS) located on the front of the unit.

## BATTERY FUEL GAUGE INDICATIONS

When your Battery Fuel Gauge is activated, the battery fuel gauge provides battery pack status information utilizing three red LED indicators, three amber LED indicators and three green LED indicators.



### Battery Fuel Gauge Indicators

A total of 9 LED indicators are provided in order to display the state of charge of the battery pack.

The indications are as follows:

9th LED (amber) . . . . .	Battery Pack is approximately 100% full
8th LED (amber) . . . . .	Battery Pack is approximately 90% full
7th LED (amber) . . . . .	Battery Pack is approximately 78% full
6th LED (amber) . . . . .	Battery Pack is approximately 67% full
5th LED (amber) . . . . .	Battery Pack is approximately 55% full
4th LED (amber) . . . . .	Battery Pack is approximately 45% full
3rd LED (red) . . . . .	Battery Pack is approximately 33% full
2nd LED (red) . . . . .	Battery Pack is approximately 20% full
1st LED (red) . . . . .	Battery Pack is approximately 10% full
STANDBY MODE. . . . .	The appropriate LED will flash every few seconds when the equipment/vehicle is not in use.

**SPECIAL NOTE:** The LED will stay on when the equipment is in use. When the equipment/vehicle is not being used the Battery Fuel Gauge will go to STANDBY MODE and it will flash every few seconds. During charge, the indicator will be Pulse from 1 LED up to the LED that indicates state of charge. This may not always happen when the charger is initially plugged in, but should pulse once the battery pack is at least 50% charged.

**FLASHING 10% led(red) . . . . .***This LED will blink when the battery pack voltage reaches a very low level (approx. 1.8 volts per cell). ie- on a 48V battery pack the voltage would be 43.20.*

**\*NOTE-** *On the BFG12V models the Low Voltage LED may begin flashing periodically once the battery falls below 32% and the 4<sup>th</sup> LED is lit. This light will come on more often as the battery is depleted to a lower level.*

***If the Low Voltage LED comes on often or becomes solid, it is recommended that use of the equipment be stopped immediately to protect electronics that are connected to the battery pack. Recharge batteries as soon as possible.***

## TROUBLESHOOTING

**PROBLEM:** The LED indicator illuminated on the Battery Fuel Gauge is flashing every few seconds.

Solution Sequence:

1. This is the STANDBY MODE and is normal when the equipment/vehicle is not in use. The flashing LED is still indicating the condition of the battery pack.
2. Start using the equipment/vehicle and the LED light will stay on.
3. If this is happening during charging, wait until the battery pack is at least 50% charged and the appropriate LED will illuminate and stay on until the charge cycle is complete and then the LED will go to standby mode.



**PROBLEM: No LED indicators illuminated on Battery Fuel Gauge.**

Solution Sequence:

1. Confirm that wires are connected properly to the battery pack.
2. Check for corrosion on the battery post. Corrosion can cause a bad connection
3. Call technical support for further assistance (800.742.2740).

**PROBLEM: After charging the battery pack, the 12<sup>th</sup> LED does not illuminate, but a lower light does.**

Solution Sequence:

1. This is an indication that the battery pack voltage is lower than what PCS would consider a full charge.
2. The equipment may have a small draw on the pack, which would cause the “static voltage” of the pack to be lower than what PCS would consider full. When the equipment is used the starting light will most likely stay on for a longer period of time in this scenario.
2. Call technical support for further assistance (800.742.2740).

**PROBLEM: While charging, an LED is just flashing every few seconds.**

Solution Sequence:

1. This is an indication that the battery pack voltage is still below 50% charged.
2. Once the battery pack voltage reaches at least 50% and the Battery Fuel Gauge senses that a charge is being applied to the pack, the appropriate light will come on and stay on. This will usually be light number 7 (amber). From that point on the lights will keep going up until the charge cycle is complete.

**LIMITED WARRANTY**

Pro Charging Systems, LLC (PCS) makes this Limited Warranty only to the original retail purchaser.

PCS warrants this Battery Fuel Gauge for one year from the date of retail purchase against defective materials and/or workmanship. If such defects should occur, this unit will either be repaired or replaced at the discretion of the manufacturer. It is the responsibility of the original purchaser to return the Battery Fuel Gauge along with proof of purchase, transportation, and/or any mailing or handling charges prepaid to the manufacturer or its authorized representative.

This limited warranty is void if the product is misused, improperly maintained, handled carelessly or incorrectly operated. Additionally, this warranty is void if the Battery Fuel Gauge is disassembled, the connecting cables are cut, the connecting plugs are cut off, the Battery Fuel Gauge is altered without authorization from PCS, the serial number is removed, or repair is attempted by anyone other than an authorized representative.

PCS makes no other warranty other than this limited warranty and expressly excludes any implied warranty, including warranty for any incidental or consequential damages.

This is the only expressed limited one year warranty authorized by PCS and does not authorize anyone to assume or make any other obligation towards the product other than this one year Limited Warranty. Some states do not allow limitation of incidental or consequential damages.

This warranty gives you specific legal rights and you may also have other rights which vary from state to state.

Please call Pro Charging Systems, LLC for full warranty information and/or service please call (800.742.2740).

## Wireless Connectivity to Your PCS Chargers & Wireless Enabled Battery Fuel Gauges

### Eagle Performance Series Chargers DeltaView Link Connectivity

Pro Charging Systems DeltaView Link App allows you to access pertinent information from your iOS or Android mobile device. DVL provides quick and easy verification that your Lift/Golf Cart/Scrubber/LSV is fully charged and gives you instant access to the charging history data. DVL can assist in making service calls much more efficient, even eliminating some calls all together, which saves you/your company time and money.

Some of the useful information you can access with DVL App include:

- Charging Data History (up to 200 Cycles)
- State of Charge Screen allows you to quickly view if your equipment is fully charged or where it is in the process.
- Date and Time Stamp information lets you know when a charger was plugged in and when it was unplugged or lost power.
- Real time data as charging is in process.
- View battery type(s) and voltage indicators.
- Displays beginning battery voltage.
- Amp hours used/Amp hours replaced as well as percentage returned to the pack
- You have the ability to assign a name and/or an asset number to your charger for quick identification.
- Location Assistance with extended wireless range
- One button upload of your historical charging profile to an email.
- One button push to call PCS customer support.
- The capability to receive messages and update your charger to the latest firmware is coming.
- Access to our App tutorial, to set up videos, to definitions, FAQ's and more....

PROView Link is now available on most Eagle Performance Series and our Patriot Series chargers. DVL can be used with Golf Carts, LSV and various Industrial Equipment.

download on the [App Store](#) or get it on [Google Play](#)

## PROView Link App Available Now

download for [iOS](#) and [Android](#)





---

## Bluetooth Wireless Enabled Battery Fuel Gauge

DeltaView Link enabled battery fuel gauges allow you to monitor state of charge and voltage from your smart device.

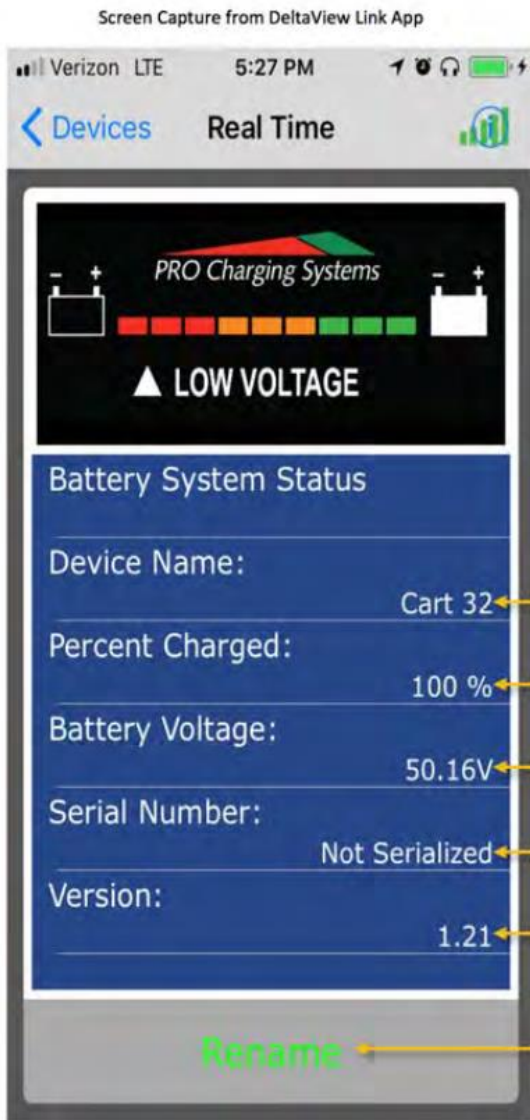

The light bar displayed in our DVL App mimics the LED indicators on your BFG for quick state of charge status right from your phone or tablet.

Identifies which BFG battery or battery pack.

Percentage charged shown for reference.

Real Time Battery Voltage is displayed.

Your BFG Serial Number will be listed here.

Shows the BFG Software Version.

Rename function allows you to personalize what you label your Battery Fuel Gauge or EPS charger.

For Golf, LSV & Industrial

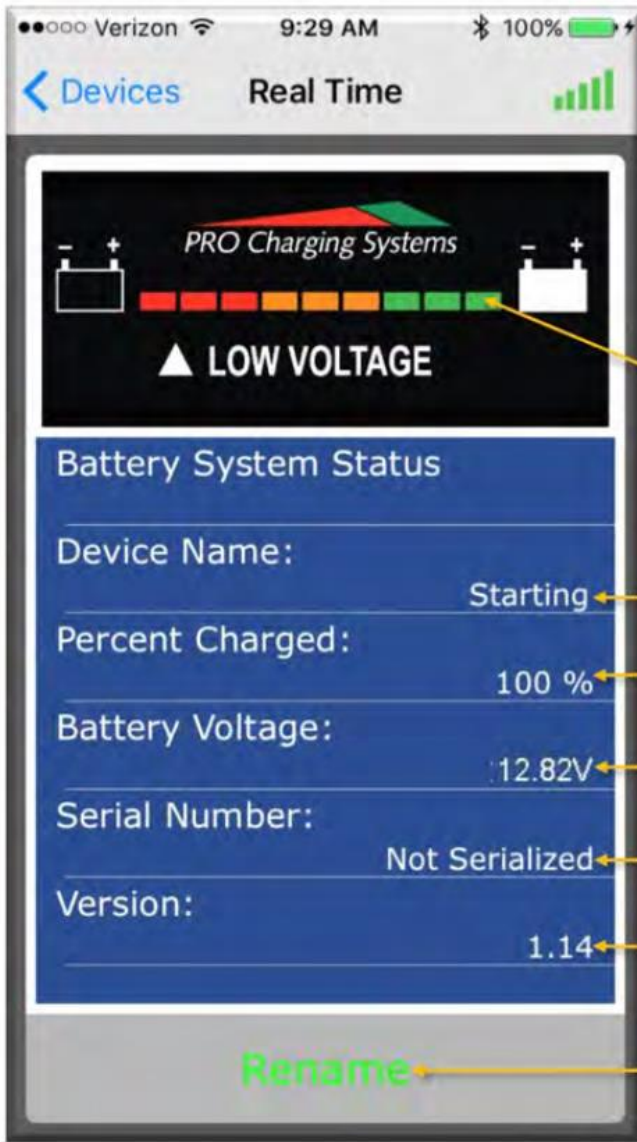

The light bar displayed in our DVL App mimics the LED indicators on your BFG for quick state of charge status right from your phone or tablet. Example Above: All lights on = 100% charged!

- Starting ← Identifies your Starting or Trolling battery(s).
- 100 % ← Percentage charged shown for reference.
- 12.82V ← Real Time Battery Voltage is displayed.
- Not Serialized ← Your BFG Serial Number will be listed here.
- 1.14 ← Shows the BFG Software Version.

Rename ← Rename function allows you to personalize what you label your Starting & Trolling battery(s)

For Marine

download on the [App Store](#) or get it on [Google Play](#)

## The Pro Charging Systems Advantage

Fill out the form below to get more information on PCS battery solutions. We guarantee the following:

- Longer Battery Life
- Reduced Warranty Returns
- Dramatic Cost Savings

Enter Your Name \*

Enter Your Email \*

Submit





# PRO Charging Systems

## Safety, Installation and Operating Instructions *Instructions importantes concernant la sécurité*

Manual for the Following Battery Charger Models:

### 48180B642%72120B



081215

#### IMPORTANT NOTICE:

Please save and read these safety, operating and installation instructions before installing or applying AC power to your Pro Charging Systems (PCS) charger. Contact technical support at PCS with any product, installation, or service questions (800.742.2740).

**INSTRUCTIONS FOR THE FOLLOWING BATTERY CHARGER MODELS:**

MODEL	AC SUPPLY	DC Output	Battery System	Battery Capacity
4818, 4818OB	120 volts, 60 Hertz	18 amps @ 48 volts		
6414OB	120 volts, 60 Hertz	14 amps @ 64 volts	64 volt, 32 cell	150-350 ah(20hr rating)
7212OB	120 volts, 60 Hertz	12 amps @ 72 volts	72 volt, 36 cell	150-350 ah(20hr rating)

**TABLE OF CONTENTS**

Important Safety Instructions..... Pages 2-3  
 Installation and Preparation .....Page 4  
 General Operation .....Pages 4-5  
 Charging Indications.....Page 6  
 Troubleshooting .....Page 6  
 LED Fault Code Indications .....Page 7  
 Limited Warranty Information.....Page 7  
 Additional Products..... Page 8

**IMPORTANT SAFETY INSTRUCTIONS**

*INSTRUCTIONS IMPORTANTES CONCERNANT LA SÉCURITÉ*

**SAVE THESE INSTRUCTIONS. This manual contains important safety and operating instructions for future reference.**

*CONSERVER CES INSTRUCTIONS. CE MANUEL CONTIENT DES INSTRUCTIONS IMPORTANTES CONCERNANT LA SÉCURITÉ ET LE FONCTIONNEMENT.*

**Understand and relate the Hazard Levels and Signal Words utilized in this manual with the following definitions:**



This symbol means: Immediate hazards, which will result in severe personal injury or death.



This symbol means: Hazards or unsafe practices, which could result in severe personal injury or death.



This symbol means: Hazards or unsafe practices, which may result in minor personal injury, product or property damage.

This symbol means BE ALERT! Your safety, or the safety of others, is involved!



## PERSONAL SAFETY PRECAUTIONS



**Always read all instructions before using your charger!**

- 1. Wear complete eye protection and clothing protection.** Avoid touching eyes while working near battery. Have plenty of fresh water and soap nearby in case battery acid contacts skin, clothing, eyes, or other surfaces. If battery acid contacts skin or clothing, wash immediately with soap and water. If acid enters eye, immediately flood eye with running cold water for at least 10 minutes and seek medical attention promptly.
- 2. Dress properly.** Wear protective, electrically nonconductive clothes and nonskid footwear. Remove personal metal items such as rings, bracelets, necklaces, and watches when working with a lead-acid battery. A lead-acid battery can produce a short-circuit current high enough to weld a ring or the like to metal, causing a severe burn. Wear restrictive hair covering to contain long hair.
- 3. Avoid working alone.** Be sure someone is within range of your voice or close enough to come to your aid when you work near a lead-acid battery.
- 4. Stay alert.** Watch what you are doing, and use common sense. Do not operate any charger when you are tired.
- 5. Keep children away.** Children must never be allowed in the work area. Do not let them handle machines, tools, battery chargers, or extension cords.
- 6. Keep work area clean.** Cluttered areas invite injuries.
- 7. Observe work area conditions.** NEVER smoke or allow a spark or flame in the vicinity of battery or engine. Don't expose to rain. Keep work area well lit.
- 8. Do not overreach.** Keep proper footing and balance at all times. Do not reach over or across electrical cables or frames.
- 9. Avoid electrical shock.** To reduce risk of electrical shock, unplug charger from outlet before attempting any maintenance or cleaning.
- 10. Do not operate charger with damaged electrical cord or plug.** To reduce risk of damage to the electrical plug and cord, pull by plug rather than by the cord when disconnecting charger. If damaged, replace the electrical cord or plug immediately.
- 11. Store idle equipment.** When not in use, store equipment in a dry location to inhibit rust. Always lock up tools and equipment and keep out of reach of children.
- 12. Maintain charger with care.** Inspect periodically and, if it has received a sharp blow, been dropped, or otherwise damaged in any way, have it repaired by an authorized technician. Do not disassemble charger; contact PCS technical support when service or repair is required (800.742.2740). Incorrect reassembly may result in risk of electrical shock or fire.
- 13. Check for damaged parts.** Before using any battery charger, carefully check any part that appears damaged to determine that it will operate properly and perform its intended function. Check for broken parts and any other condition that may affect proper operation. Any part that is damaged should be properly repaired or replaced by a qualified technician. Do not use the charger if any part does not operate properly.
- 14. Replacement parts and accessories.** When maintaining, only use accessories intended for use with this charger. Approved accessories are available from Pro Charging Systems (800.742.2740).

15. **CAUTION:** To reduce the risk of fire, use only on circuits provided with 15 amperes branch circuit protection at 100 VAC and 115 VAC and 10 amperes branch circuit protection at 230 VAC in accordance with the national electrical code, ANSI/NFPA 70

**ATTENTION:** Pour réduire le risque d'incendie, utilisez uniquement sur les circuits munis d'une protection de circuit 15 ampères de branche à 100 VAC et 115 VAC et protection de circuit 10 ampères de branche à 230 VAC en conformité avec le Code canadien de l'électricité CEC Partie 1

### SAVE THESE INSTRUCTIONS!

## INSTALLATION AND PREPARATION

**Important note:** if the PCS charger has a model number containing the letters OB, it not intended to be used as a stationary device.



**WARNING** To reduce risk of battery explosion, follow these instructions, those published by the battery manufacturer, and by the manufacturer of any equipment that you intend to use in the vicinity of battery. Review all cautionary markings on these products and on the engine.

*Pour réduire le risque d'explosion, lire ces instructions et celles qui figurent sur la batterie.*

If it is necessary to relocate the battery for charging, first remove the grounded terminal from the battery. Then make sure all accessories are off, so as not to cause battery arcing.



**WARNING** RISK OF EXPLOSIVE GASES: WORKING IN THE VICINITY OF A LEAD-ACID BATTERY IS DANGEROUS. Batteries generate explosive gases during normal battery operation. For this reason, it is of utmost importance that prior to each use of your charger, you read this manual and follow the instructions exactly.

*Il est dangereux de travailler a proximité d'une batterie au plomb. Les batteries produisent des gaz explosifs en service normal. Il est aussi important de toujours relire les instructions avant d'utiliser le chargeur et de les suivre à la lettre.*

**Do not operate charger in a closed-in area or restrict ventilation in any way.**

***Ne pas faire fonctionner le chargeur dans un espace close et/ou ne pas gener la ventilation.***

Clean battery terminals. Be careful to keep corrosion from coming into contact with eyes.

Add distilled water to each cell until battery acid reaches level specified by battery manufacturer. This helps purge excessive gas from cells. Do not overfill. For a battery without cell caps, carefully follow manufacturer's recharging instructions. Study all battery manufacturers' specific precautions such as removing or not removing cell caps while charging and recommended rates of charge.

When using an extension cord, make sure:

- that pins on plug of extension cord are the same number, size, and shape as those of the charger's plug;
- that extension cord meets UL (Underwriters Laboratories, Inc.) acceptance;
- that wire size is large enough for AC ampere rating of charger.



**CAUTION** Always make your extension cord connection on the charger side before connecting to a nearby 120VAC GFCI protected (Ground Fault Circuit Interrupt) outlet. Failure to use a GFCI outlet may result in electrical shock. Note: U(Universal) chargers should be connected to a 110, 115 or 230VAC GFCI protected outlet. The DC connection should always be made before connecting or disconnecting the AC side.

Note: Extension cords should be industrial grade/heavy duty UL approved and grounded. Check extension cord before use for damage, bent prongs and cuts. Replace if damaged.

Connect the extension cord to the charger; then proceed to plug the extension cord to the GFCI protected (Ground Fault Circuit Interrupt) outlet.

Always remove the extension cord from the GFCI protected outlet first when charging is completed, followed by unplugging the charger.

## GENERAL OPERATION



**WARNING** Use charger for charging a LEAD-ACID (lead acid, sealed lead acid, gel cell and AGM) battery only. It is not intended to supply power to a low voltage electrical system other than in a starter-motor application. Do not use battery charger for charging dry-cell batteries that are commonly used with home appliances. These batteries may burst, causing personal injury and damage to property.

Utiliser le chargeur pour charger une batterie au plomb uniquement. Ce chargeur n'est pas conçu pour alimenter un réseau électrique très basse tension ni pour charger des piles sèches. Le fait d'utiliser le chargeur des piles sèches pourrait entraîner l'éclatement des piles et causer des blessures ou des dommages.

 **WARNING** DO NOT attempt to attach a charger to a battery pack if the output of the charger does not match the battery pack voltage. Example: Model i-3625 is a 36 volt output charger and is only usable on 36 volt battery systems. Charger and battery damage can occur.

 **WARNING** Be extra cautious to reduce risk of dropping a metal tool onto battery. It might cause a spark or short-circuit a battery or other electrical part, possibly resulting in an explosion. If damaged, contact PCS (800.742.2740).

 **CAUTION** NEVER charge a frozen battery.  
*Ne jamais charger une batterie gelée.*

Assure that the area around your charger and batteries is properly ventilated. Connect your extension cord, with no AC Power present, to the battery charger and proceed to plug your extension cord into a 120VAC GFCI protected (Ground Fault Circuit Interrupt) outlet.

 **DANGER** Risk of electrical shock! Do not touch uninsulated parts of the battery charger output connector, battery connector, or battery terminals.

Once you plug in your PCS battery charging system, the charge cycle will begin automatically. State of charge will be displayed by illumination of the Light Emitting Diodes (LEDS) on the battery status indicator located on the front of the unit.

 **WARNING** DO NOT connect or disconnect the DC output electrical cord to or from the battery receptacle when the charger is on. Arcing and / or burning of the plug and receptacle could result and could cause the batteries to explode. If the charger must be stopped, first disconnect the AC power supply cord from its outlet, then disconnect the charger DC output plug from the battery receptacle.

We recommend that you leave your system plugged in. This will reduce sulfation on the lead plates of the batteries and allow your PCS charging system to keep your batteries fully maintained and ready to perform at their best.

 **CAUTION** To reduce the risk of fire, use only on circuits provided with 15Amperes Branch Circuit Protection in accordance with the National Electrical Code, ANSI/NFPA 70.

 **CAUTION** Study all battery manufacturers' specific precautions such as removing or not removing cell caps while charging and recommended rates of charge.

*Prendre connaissance des mesures de précaution spécifiés par le fabricant de la batterie, p. ex., vérifier s'il faut enlever les bouchons des cellules lors du chargement de la batterie, et les taux de chargement recommandés.*

 **CAUTION** Never place the charger directly above or below the battery being charged; gases or fluids from the battery will corrode and damage the charger. Locate the charger as far away from the battery as DC cables permit.

*Ne jamais placer le chargeur directement sous la batterie à charger ou audessus de cette dernière. Les gaz ou les fluids qui s'échappent de la batterie peuvent entraîner la corrosion du chargeur ou l'endommager. Placer le chargeur aussi loin de la batterie que les cables c.c. le permettent.*

 **CAUTION** If it is necessary to remove battery from vehicle to charge it, always remove grounded terminal from battery first. Make sure all accesproes in the vehicle are off in order to prevent an arc.

*S'il est nécessaire de retirer la batterie du véhicule pour la charger, toujours d'ébrancher la borne de mise à la masse en premier. S'assurer que le courant aux accessoires du véhicule est coupe afin d'éviter la formation d'un arc.*

 **CAUTION** Never smoke or allow an open spark or flame in the vicinity of the BATTERY the battery or engine.

*Ne jamais fumer près de la batterie ou du moteur et éviter toute étincelle ou flamme nue à proximité de ces dernie.*

 **CAUTION** Working in the vicinity of a lead-acid battery is dangerous. Batteries generate explosive gases during normal operation. For this reason it is of the utmost importance that prior to each use of your charger, you read and follow the instructions provided exactly.

*Il est dangereux de travailler a proximité d'une batterie au plomb. Les batteries produisent des gaz explosifs en service normal. Il est aussi important de toujours relire les instructions avant d'utiliser le chargeur et de les suivre à la lettre.*

## CHARGING INDICATIONS

When your battery charging system is activated, the battery status indicator provides charging information utilizing five red LED indicators and one green LED indicator.

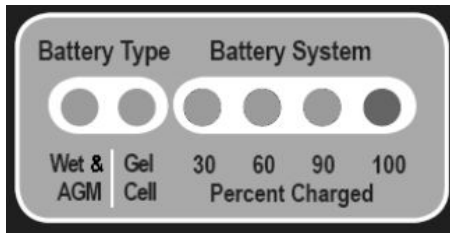

### Battery Type Indicators

Two amber LED indicators are provided in order to display what type of battery the charger has been programmed to charge. **NOTE:** For information on reconfiguring the battery type, please contact technical support (800.742.2740).

### Battery System Percent Charged Indicators

Four LED indicators are provided in order to display the progress of the charge cycle in percentage of charge.

Indications are as follows:

1 <sup>ST</sup> Amber LED . . . . .	Illuminated configured for Wet Cell and <b>AGM*</b> batteries
2 <sup>ND</sup> Amber LED . . . . .	Illuminated configured for Gel Cell batteries
1 <sup>ST</sup> RED / 100% GREEN alternate. . . . .	Charger plugged into A/C not connected to battery and sending DeltaView signal
1 <sup>ST</sup> RED LED . . . . .	Charging - Initial Charging Up To 30%
2 <sup>ND</sup> & 3 <sup>RD</sup> RED LEDS . . . . .	Charging - 60% Complete
1 <sup>ST</sup> , 2 <sup>ND</sup> & 3 <sup>RD</sup> RED LEDS. . . . .	Charging - 90% Complete
BLINKING GREEN LED . . . . .	Finishing Stage (Note: Battery Type Indicator will also blink during this stage)
STEADY GREEN LED . . . . .	Charge Complete –Float/Maintenance Mode–On for 5 minutes and off for 60 minutes

**\*We normally recommend our STANDARD Delta Volt profile for AGM Batteries. There are some cases where particular AGM batteries are manufactured to different specifications and may need a special profile with a much lower finish voltage limitation. In these cases we will do our best to accommodate your unique need.**

The green LED is illuminated whenever the charge cycle has terminated and the internal circuitry has determined the batteries to be fully charged. The green LED will blink during the finishing stage of the charge cycle. After the completion of the charge cycle, the green LED will remain on steady during the float-maintenance stage. ***During this final stage current is only flowing to the battery system for 5 minutes and then current will stop completely for 60 minutes.***

***Your system provides an equalization stage every 30 days while plugged in. If the charger is normally disconnected from A/C after completing charge, equalization can be accomplished by plugging back into A/C whenever this stage is desired. Battery manufacturers recommend that equalization is done once a month in order to further reduce sulfation on the lead plates of a battery, which helps promote longer battery life. Note: During this process the LEDs will go through their normal routine (Red LEDs counting up for % of charge along with the illuminated Red LED Battery Type) and then the Green LED and Red Battery Type LED will blink) until the unit returns to the maintenance mode and a steady Green LED and steady Red Battery Type LED. (Not applicable to Gel Profile)***

## TROUBLESHOOTING

**PROBLEM: No LED indicators illuminated on battery status indicator.**

Solution Sequence:

1. Confirm that current is being delivered to the charger. Use a meter or test light to check the AC power supply from its source through all connecting points up to the charger.
2. Check that the AC circuit breaker (on front of the unit) is depressed.
3. Call technical support for further assistance (800.742.2740).

**PROBLEM: The charge status indicator changes rapidly back and forth from red to green or the green LED will not illuminate after excessive charging time (24 hours or more).**

Solution Sequence:

1. Disconnect AC power from the charging system. This indication may signify a possible battery problem.
2. Call technical support for further assistance (800.742.2740).

**PROBLEM: A green LED was illuminated before disconnecting the power from the charger, but upon reconnection, red LEDs appear and remain on.**

This is the normal operating procedure for the system. It indicates that a reanalysis of the battery status was initiated and after a series of steps the green LED will illuminate.

## **LIGHT EMITTING DIODES (LED) FAULT CODE INDICATIONS**

The microprocessor is constantly monitoring the charger circuitry and will both detect and display blinking LED indications if a fault is detected. The battery type LED will be **OFF** during a fault code condition.

### **30% RED LED BLINKING .....NO BATTERY DETECTED**

This indication occurs whenever the charger circuitry cannot detect a battery. The charger circuitry will not allow charge current to flow under this condition. With the AC power supply cord unplugged, check the connection to the batteries for proper polarity (black wire to negative or -). Also check for corrosion free secure connections to the battery.

### **30 & 60% RED LEDS BLINKING .....FORMING STAGE TIMEOUT SHUTDOWN**

This indication occurs if the battery voltage has not risen above 1.75 volts per cell within the first 3 hours of charging. This indicates that a possible battery problem exists and that the charge cycle has been terminated at this point.

### **30, 60 & 90% RED LEDS BLINKING.....OVERALL TIMER SHUTDOWN**

This indication occurs if the charger has not completed the charge cycle within the allowable factory set time period. This indicates that a possible battery problem exists and that the charge cycle has been terminated at this point.

### **30 & 90% RED LEDS BLINKING .....INTERNAL OVERTEMP SHUTDOWN**

This indication occurs if the charger circuitry has detected operating temperatures inside the charger enclosure that are above factory specified levels. This could indicate that a possible charger problem exists and that the charge cycle has been terminated.

### **30% RED & 100% GREEN LEDS BLINKING ..... BULK STAGE SHUTDOWN**

This indication occurs if the battery voltage does not rise properly during the Bulk Stage. This indicates that a possible battery problem exists and that the charge cycle has been terminated at this point. Please call technical support for further assistance (800.742.2740).

### **30% RED & 100% GREEN LEDS ALTERNATE BLINKING ON OFF.....DELTAVIEW SIGNAL OR NO BATTERY DETECTED**

This will be the NORMAL indication when the charger is plugged into A/C but not connected to a battery pack, allowing the DeltaView signal to be retrieved with a DeltaView Reader. This can also be considered the NO BATTERY DETECTED fault code. Please call technical support for further assistance (800.742.2740).

Note: Disconnecting and reconnecting the AC power supply cord will reset the charger.

## **LIMITED WARRANTY**

Pro Charging Systems, LLC (PCS) makes this Limited Warranty only to the original retail purchaser.

PCS warrants this battery charger for three years (unless the charger is used in a Restricted Market) from the date of retail purchase against defective materials and/or workmanship. Restricted markets include markets outside of the USA, Rental applications and Heavy Industrial applications. Sometimes RM is designated in the PCS Part number when ordered, but is not part of the model number. Chargers used in Restricted Markets will have a warranty period of 18 months from the date of retail purchase against defective materials and/or workmanship. CR refers to "Certified Reconditioned" and designates a 1 year warranty.

If such defects should occur, this unit will either be repaired or replaced at the discretion of the manufacturer. It is the responsibility of the original purchaser to return the charger along with proof of purchase, transportation, and/or any mailing or handling charges prepaid to the manufacturer or its authorized representative. Chargers that are purchased more than two years beyond the date of production will automatically have a warranty start date that will be the two year anniversary of the production date.

This limited warranty is void if the product is misused, improperly maintained, handled carelessly or incorrectly operated. Additionally, this warranty is void if the charger is disassembled, the charger's charge cables are cut, the power cord is cut off, the charger is altered without authorization from PCS, the serial number is removed, or repair is attempted by anyone other than an authorized representative. PCS makes no other warranty other than this limited warranty and expressly excludes any implied warranty, including warranty for any incidental or consequential damages. This is the only expressed limited three year warranty authorized by PCS and does not authorize anyone to assume or make any other obligation towards the product other than this three year Limited Warranty. Some states do not allow limitation of incidental or consequential damages.

This warranty gives you specific legal rights and you may also have other rights which vary from state to state. Please call Pro Charging Systems, LLC for full warranty information and/or service please call (800.742.2740).



## Installation, Operation & Maintenance Manual

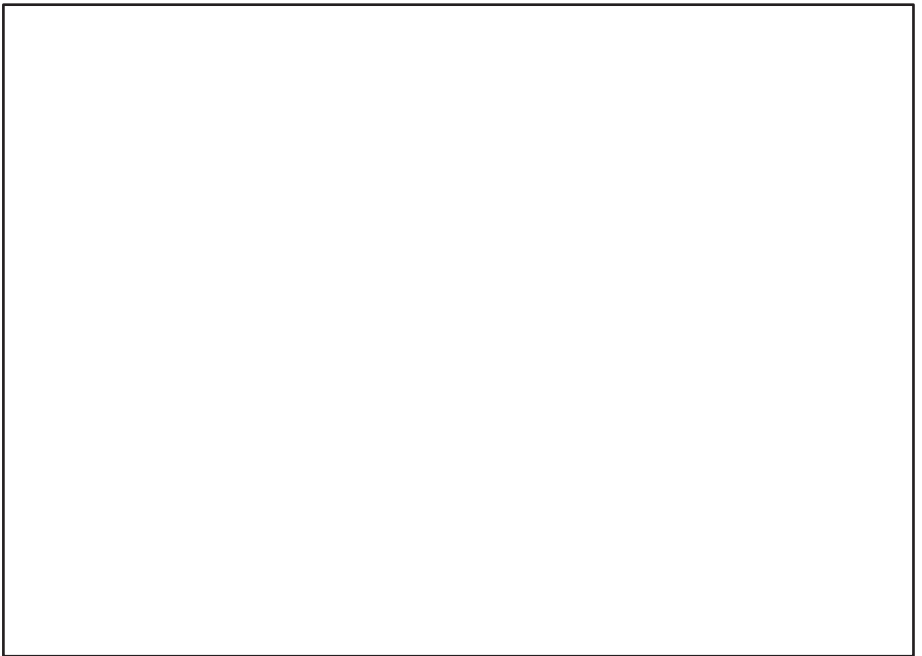

Picture may differ from your specific application

For Pro-Fill kits with part numbers beginning in "BG"

BL-175

9-20-13

# General Information & Precautions

This publication provides detailed instructions for installing the single point watering system kit. Thoroughly review this document before any installation procedures are performed.



The following safety statements relate to specific safety issues and must be read, understood, and heeded before a kit is installed. Failure to do so could result in personal injury and/or property damage.

## **DANGER**

- Battery – Explosive gases! Do not smoke. Keep sparks and flames away from the vehicle and service area. Ventilate when charging or operating vehicle in an enclosed space. Wear a full face shield and rubber gloves when working on or near batteries.
- Battery – Poison! Contains acid! Causes severe burns. Avoid contact with skin, eyes, or clothing.  
Antidotes:
  - External: Flush with water. Call a physician immediately.
  - Internal: Drink large quantities of milk or water. Follow with milk of magnesia or vegetable oil. Call a physician immediately.
  - Eyes: Flush with water for 15 minutes. Call a physician immediately.

## **WARNING**

- Follow the procedures exactly as stated in this instruction, and heed all DANGER, WARNING, and CAUTION statements in this instruction as well as those on the vehicle and battery charger.
- Only trained technicians should service or repair the single point watering system. Anyone doing even simple repairs or service should have knowledge and experience in plumbing, electrical and mechanical repair. The appropriate instructions must be used when performing maintenance, service, or accessory installation.
- Prior to servicing the vehicle or leaving the vehicle unattended, turn the key switch OFF, remove the key, and chock the wheels when servicing the vehicle.
- Wear safety glasses or approved eye protection when servicing any part of the watering system. Wear a full face shield and rubber gloves when working on or near batteries.
- Do not wear loose clothing or jewelry such as rings, watches, chains, etc., when servicing the vehicle or battery charger.
- Moving parts! Do not attempt to service the vehicle while it is running.
- Use insulated tools when working near batteries or electrical connections. Use extreme caution to avoid shorting of components or wiring.
- If wires are removed or replaced, make sure wiring and wire harness are properly routed and secured. Failure to properly route and secure wiring could result in vehicle malfunction, property damage, personal injury, or death.

# Package Contents

8-volt manifold shown

<u>Kit Size</u>	<u>Qty of manifolds</u>
12 volt	2
24 volt	4
36 volt	6
48 volt	8 (6-volt manifolds)
48 volt	6 (8-volt manifolds)

Coupler & dust Cover:  
Qty = 1

Red End caps  
Qty = 9

Tubing  
Qty = Varies on Kit Size.  
Golf kits include precut tubing

Note: pictures may differ slightly from your specific application



# Installation

**Step 1** - Remove Vent Caps and Insert Pro-Fill Manifold Assembly.

**Step 2** - Press Manifold Home  
- Ensure the rubber washer is correctly seated around the refill valve.

**Step 3** - Secure Valves  
- Rotate each valve 1/4 turn in a clockwise motion to secure it to the battery.

**Step 4** - Install Tubing  
Plumb all of the manifolds together with the included tubing. For pre-cut kits, please see diagrams on the following page for proper tube routing. For universal kits, when cutting tubing ensure there is enough slack to create a slight bend in the tubing. Place the feed tube with coupler attached on a manifold that is near the middle of the plumbing so that water can be distributed to all batteries evenly.

**Step 5** - Install Red Caps  
- Place a red end cap on each of the remaining bars.

# Watering Procedures

## 1. Water After Charge

Electrolyte levels drop during discharge and rise during charge. In addition, charging generates heat, fluid expansion, and explosive gases. Watering a battery before charge (or with a low charge level) can lead to boil over, resulting in potential damage to the watering system, battery, and vehicle.

When needed, water must only be added to fully charged battery. If the battery has been neglected and water levels have fallen below the plates, water should be manually added to just cover the plates. After the battery has been charged you can finish topping up with the watering system.

## 2. Watering Intervals

Watering intervals are dependent on the local climate, charging methods, application, and age of batteries. FLOW-Rite recommends checking consumption rates manually or with the optical indicator (when equipped). New batteries should be checked once a month and older batteries weekly until water consumption rates are known.

Typically for a heavy use application, watering a maximum of once per week is recommended, and for light use applications once per month. Do not water a battery that has been sitting for an extended period of time with no activity (non-use or not on charge) such as a battery that has sat idle over the weekend. It is best to water a warm battery that has just been fully charged.

**Important:** Water quality is important to maintain the life of your battery and watering system. Always use water that meets the quality requirements of your battery's manufacturer.

# Operation

For successful operation of your Single Point Watering system always:

1. Only Use Flow-Rite approved equipment.

**Warning!** Use of unapproved equipment or modification of approved equipment can lead to system failure and will void your warranty.

2. Always follow FLOW-Rite's required watering procedures.
3. Perform regular scheduled maintenance!

**Warning!** Only fill batteries after they have been fully charged and require water.

**Important:** If you are using a hand pump, cart, or gravity feed water supply to fill your Millennium SPW™ system, please refer to their instructions for proper operation!

## Step 1 - Qualify Water Supply

- Check flow rate through included purger by mating purger with hose end assembly. Verify that a minimum of 2 GPM (gallons per minute) is achieved. This can be measured with a bucket and a stop watch or a watch with a second hand.

**Note:** should a 2 GPM flow rate not be produced refer to the troubleshooting guide in your water supply's instruction booklet.

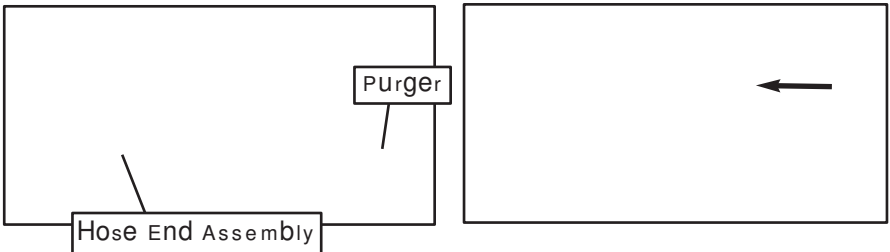

## Step 2 - Remove Dust Cover



# Operation Continued

## Step 3 - Mate Couplers

- Insert the male coupler on the SPW system into the female coupler on the end of the water supply.



## Step 4 - Observe Flow Indicator

- The red balls inside the flow indicator will begin to spin indicating that water is flowing into the battery. As the cells fill and the valves shut off, the balls will begin to spin slower until they come to a stop. This indicates that all valves have shut off and filling is complete.



## Step 5 - Disconnect

- When the balls stop spinning, and not before, immediately disconnect the couplers by depressing the push button on the female coupler.

**Warning!** If the water supply is left connected after the filling process is finished, it could lead to an overflow.

Disconnecting before the balls come to a complete stop will lead to underfilled cells.

**CAUTION:** If at any time during the filling process you have a valve failure, disconnect immediately and refer to the troubleshooting section.



## Step 6 - Replace Dust Cover

- Place dust cover back over the male coupler.

# Regular Maintenance

Your single point watering system requires regular preventative maintenance on at least a quarterly basis.

## **1. Check all screens and/or filters on water supplies**

Clean or replace all filters & line strainers as necessary. Failure to do so can cause a reduction in the water pressure and flow rates needed to operate the system properly. A filter screen can be found on the inlet of all regulators, and a line strainer on all supply hoses. Pump powered water supplies include a strainer on all suction hoses. For deionizers be sure to replace the filter cartridges as indicated by the water quality light. Consult your water supply's manual for detailed instructions.

## **2. Inspect the condition of all tubing, connections, and couplers.**

Make sure that all parts are in good working condition and are secure, leak free, and properly connected. The coupler must have an O-ring and dust cover properly attached.

## **3. Electrolyte Levels**

Flow-Rite recommends checking the electrolyte level in each cell for accuracy after the system has been installed and operational for three months.

# Seasonal Maintenance

## Water Supplies

Water supplies must be drained and stored in an empty state if they will be exposed to freezing temperatures. Failure to do so can cause permanent damage.

## Watering Systems

If you have vehicles that are taken out of service or put into storage for a period of 6 weeks or longer, your single point watering system will require seasonal maintenance. To winterize the SPW system simply drain any remaining water from the feed tube. Additionally the following steps need to be followed when bringing your vehicle back into service.

1. After the batteries have been fully charged/equalized, connect the system to its water supply for 3-5 seconds then disconnect regardless of whether or not the batteries are completely full.
2. Return the vehicle back to normal operation.
3. Place the vehicle back into its regular watering schedule (waiting at least one week until next watering).

# Operating Specifications

## Operating Requirement of SPW system

Flow-Rate:	2.0-5.0 gallons per minute* 7.6-19.0 Litres per minute
Pressure Range:	3.0 - 35.0 PSI (no flow, static) 0.21-2.4 bar
Temp. Range:	Freezing - 150° F Freezing - 65.5° C

## Water Supply Operating Requirements

Inlet Pressure Range	40-100 PSI (no flow, static)
Temp. Range	33 - 150° F 1 - 65.5° C

All product specifications and requirements should be met for proper operation of your Flow-Rite SPW system. Contact your battery supplier or Flow-Rite Controls if you have any questions regarding product specifications or how to verify a water supply.

\*Flow rate should be measured at the end of a purger (female / male coupler combination).

# Troubleshooting

If you notice reduced run time on your vehicle, check to see that each cell is filled to the proper level. In the event that a cell is not showing water, connect system to its water supply. Recheck the level of low cells. If they are still low, call for service.

In the event that a valve does not shut off, qualify water supply to ensure that it is producing 2GPM (measured through the purger). If the water supply qualifies, call for service. If it does not qualify, perform Maintenance procedures and requalify. If it does not qualify after performing Maintenance, call for service.

# Warranty

## **5 Year Limited Warranty for Pro-Fill SPW**

*Flow-Rite Controls Warranty Policy for Millennium SPW Systems as used on flooded lead acid batteries*

Flow-Rite Controls warrants to Purchaser that its product, the Pro-Fill Single Point Watering (SPW) kit, will be free of all defects in material and workmanship for five (5) years after the date of purchase. If within five years of the date of purchase, the Pro-Fill SPW kit, fails to perform due to a manufacturing defect, Flow-Rite Controls will repair or replace the Pro-Fill SPW kit free of charge.

A Return Goods Authorization Number (RGA) must be obtained from Flow-Rite Controls (through your Pro-Fill supplier) prior to returning product for warranty consideration. Purchaser must send any product covered under this warranty, along with a copy of supplier's invoice and description of the problem to: Flow-Rite Controls, 960 74th St SW, Byron Center, MI 49315.

**Disclaimer of Warranties: It is expressly understood and agreed that Flow-Rite Controls shall not be liable for damages or injuries to persons or property. Failure to promptly report a malfunction in your system may limit your coverage. This limited warranty expressly excludes any incidental or consequential damages. Because Flow-Rite's warranty excludes any incidental or consequential damages, Flow Rite recommends for the first three months checking electrolyte levels once a month. Thereafter, check electrolyte level once per quarter.**





Flow-Rite Controls

960 74th Street

Byron Center, MI 49315

PH: 616-583-1700 FAX: 616-878-5151

[www.flow-rite.com](http://www.flow-rite.com)

## 2 Piece Windshield Installation



Small section of the windshield

Add rubber pads at on both sides at each corner and middle to keep the windshield away metal frame. Add the foam pieces to the back side of the windshield so that the windshield does not touch the metal frame.





Windshield straps



Install the windshield strap. Insert for the front.



View of the strap from behind.



Slide the strap into the plastic at an angle.



Center windshield and pull strap tight





Install upper windshield piece overlapping the lower windshield piece

Add rubber pads at on both sides at each corner and middle to keep the windshield away metal frame. Add the foam pieces to the back side of the windshield so that the windshield does not touch the metal frame.



Rubber pads



Use the rubber pads anywhere you see the windshield may touch the metal frame. Add rubber pieces between the upper windshields and the lower Windshields so that the plastic does not rub against





## **Flexibility**

- Programmable to match the unique characteristics of each separately excited motor model
- Programmable low-voltage battery discharge interrupt (BDI) cutbacks will limit motor current to extend the battery charge
- Up to three speed limit inputs with programmable cut-back speeds and priority level

## **Control**

- Full bridge field control design allows reversing without the use of direction contactors
- Armature current controlled at all times to help reduce brush wear and arcing
- Regenerative braking harnesses excess energy to extend the battery charge
- Motor over-speed protection is ensured using the motor field

## **Communications**

- Integrated LEDs flash information and error codes for basic controller diagnostics
- Protected I/O connections

## **Safety**

- Regenerative braking provides vehicle speed control at any throttle position when going down ramps and channels the extra energy back into the batteries for longer battery life
- Adjustable regen settings allow for braking strength to be tailored to the specific vehicle for safety during stopping and forward/reverse transitions
- Safe-Sequencing including high pedal disable (HPD) and static-return-to-off (SRO) interlock ensure safe startup and vehicle operation
- Controlled temperature cutback on armature and field drive current limits ensures there is no sudden loss of power under any thermal condition



## FEATURES AND BENEFITS

### Apps and Configuration Tools (TSX3.0 Controller only)

- Various iOS and Android apps for smart phones and tablets are available at the App Store and Google Play (Free APPs).
  - Android Phones-Down Load from Google Play-Search Apps-“Navitas Vehicle Systems Ltd”  
Select-Install
  - iPhone-Down Load from App store-Search “Dashboard Navitas”  
Select-Install
  - Complete Installation of Controller in Vehicle
  - Make sure Bluetooth is turned on your phone to make app work

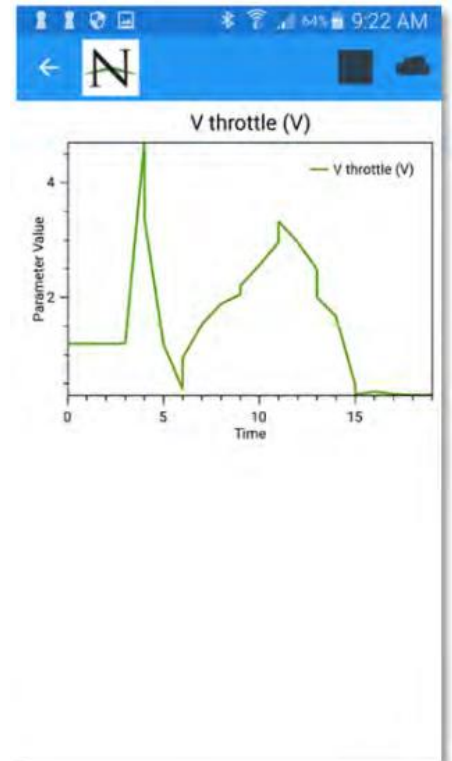

- Publicly available Dashboard Apps allow the vehicle owners to remotely lock their vehicle, monitor usage and performance or notify their dealers with diagnostic information
- Authorized Dealer Apps allow modifications for basic vehicle types and settings.